



AccuMapTM
and
UltraMapTM

**INSTALLATION AND
OPERATION INSTRUCTIONS**



Copyright © 1998 Eagle Electronics. All rights reserved.

UltraMap™ and AccuMap™ are trademarks of Eagle Electronics.

WARNING!

USE THIS UNIT ONLY AS AN AID TO NAVIGATION. A CAREFUL NAVIGATOR NEVER RELIES ON ONLY ONE METHOD TO OBTAIN POSITION INFORMATION.

Never use this product while operating a vehicle.

CAUTION

When showing navigation data to a position (waypoint), this unit will show the shortest, most direct path to the waypoint. It provides navigation data to the waypoint regardless of obstructions. Therefore, the prudent navigator will not only take advantage of all available navigation tools when travelling to a waypoint, but will also visually check to make certain a clear, safe path to the waypoint is always available.

The operating and storage temperature for your unit is from -4 degrees to +167 degrees Fahrenheit (-20 to +75 degrees Celsius). Extended storage temperatures higher or lower than specified will cause the liquid crystal display to fail. Neither this type of failure nor its consequences are covered by the warranty. For more information, consult the factory customer service department.

All features and specifications subject to change without notice.

Eagle Electronics may find it necessary to change or end our policies, regulations, and special offers at any time. We reserve the right to do so without notice.

All screens in this manual are simulated.

This device complies with Part 15 of the FCC Rules. Operation is subject to the following two conditions: (1) this device may not cause harmful interference, and (2) this device must accept any interference received, including interference that may cause undesired operation.

Note:

This equipment has been tested and found to comply with the limits for a Class B digital device, pursuant to Part 15 of the FCC Rules. These limits are designed to provide reasonable protection against harmful interference in a residential installation. This equipment generates, uses and can radiate radio frequency energy and, if not installed and used in accordance with the instructions, may cause harmful interference to radio communications. However, there is no guarantee that interference will not occur in a particular installation. If this equipment does cause harmful interference to radio or television reception, which can be determined by turning the equipment off and on, the user is encouraged to try to correct the interference by one or more of the following measures:

- Reorient or relocate the receiving antenna.
- Increase the separation between the equipment and receiver.
- Connect the equipment into an outlet on a circuit different from that to which the receiver is connected.
- Consult the factory customer service department for help.

Table of Contents

INSTALLATION	1	Edit Position	40
Mounting	1	Edit Name	40
Power Connections	2	Edit Icon	40
Cable Connections	2	Delete a Waypoint	40
AccuMap	3	Delete All Waypoints	41
UltraMap	4	Move a Waypoint	41
Antenna	5	Waypoint Options	41
Transducer	6	WAYPOINT NAVIGATION	42
INTRODUCTION TO GPS	10	Navigate to a cursor location	42
OPERATION	12	Navigate to a Waypoint using the Map	43
Satellite Status Screen	13	CANCEL NAVIGATION	43
Finding Your Position	14	ROUTES	43
Auto Search	14	Create a Route	43
Manual Initialization	14	Add From Waypoint List	44
Position Acquisition	15	Add From Map	44
Modes	15	Delete a Waypoint	45
Navigation Screens	15	Waypoint Statistics	45
Course Deviation Indicator (CDI)	18	Following a Route	45
Map	18	Waypoint Information	47
Cursor	19	Delete a Route	47
Map Setup	20	SYSTEM SETUP	48
Change Maps	20	Sound	48
Map Options	21	Contrast	48
Map Orientation	21	Backlight	48
Range Rings/Grid Lines	22	Set Local Time	48
Autozoom	22	Units of Measure	49
Map Details	23	NMEA / DGPS	49
Earth Map On/Off	23	Configure NMEA Output	50
Text Labels	23	DGPS	50
Map Detail	23	Serial Communication Setup	51
Gray Fill	24	Reset Groups	51
Map Boundaries	24	Reset Options	51
Map Symbols	24	System Info	52
Locations	25	GPS SETUP	52
Contour Lines	25	Position Format	52
Plot Trail Options	25	DATUM	53
Clear Trail	25	PCF (Position Correction Factor)	54
Flash Trail	25	POSITION PINNING	55
Show Trail	25	GPS ALARMS	56
Save Trail	25	DGPS MESSAGES	57
Update Trail	26	SUN/MOON CALCULATOR	57
ICONS	26	SIMULATOR	58
MAP DOWNLOADING	28		
WINDOWS	29		
Reprogram Boxes	34		
RESET GROUPS	35		
WAYPOINTS	35		
Waypoint Menu	35		
Saving Your Present Position as a			
Waypoint (Quick Save Method)	35		
Saving The Cursor Position as a			
Waypoint	36		
Saving Your Present Position as a			
Waypoint (Select Number Method) ...	36		
Saving a New Position	37		
Waypoint Averaging	37		
Project a Waypoint	38		
Selecting a Waypoint	39		
From List	39		
By Name	39		
Editing a Waypoint	40		

Table of Contents

SONAR OPERATION	59
Sonar Modes	59
Full Chart	59
Split Chart	59
Digital/Chart	59
Automatic	60
Sonar Options	60
Sensitivity	60
Grayline	61
Adjust Surface Clarity (SCC)	61
ASP (Advanced Signal Processing)	62
Range - Automatic	62
Manual	63
Chart Options	63
Chart Speed	63
Chart Stop	63
Zoom	64
Fish ID	65
FISHTRACK™	65
Chart Display	66
Zoom Bar	66
Zone Bar	67
Chart Cursor	67
Digital Sonar	67
Alarms	68
Depth Alarms	68
Zone Alarm	69
Fish Alarm	69
Keel Offset	69
Calibrate Speed	70
SONAR TROUBLESHOOTING	71
UPS Return Service	74
Warranty	76
Datum List	77

Notes:

Thank you for purchasing an Eagle product! You won't find another combination GPS and sonar unit with these features and power for the money! Each of our products is designed and manufactured to precision tolerances for long life under extreme conditions. We hope that you'll enjoy this product for years.

This manual covers both the Eagle UltraMap™ and AccuMap™. Both are 12-channel GPS receivers, however the UltraMap™ also has a sonar built into the unit. The installation of these two products vary, otherwise the GPS operation of the two units is nearly identical.

No matter which unit you own, please read the installation section carefully, especially the transducer section. Many times future trouble can be avoided by carefully locating and wiring the equipment.

If you do have problems, please read the troubleshooting section in the back of this manual. You may find the solution to your problem there. The Eagle customer service department also has representatives available to answer your questions on our toll-free telephone lines. See the back page of this manual for more information.

We want your experience with our equipment to be a happy one. Good luck, and good fishing.

INSTALLATION

Mounting - All Units

Install the unit in any convenient location, provided there is clearance behind it when it is tilted for the best viewing angle. Holes in the bracket base allow wood screw or through-bolt mounting. You may need to place a piece of plywood on the back of thin fiberglass panels to secure the mounting hardware. Make certain there is enough room behind the unit to attach the power and transducer cables.

The gimbal bracket will also accept the GBSA-1 swivel bracket adapter that lets you rotate the unit a full 360°.

The smallest hole that allows one power or transducer connector to pass through is 3/4".

Power Connections - All Units

This unit works from a twelve-volt battery system. For the best results, attach the power cable directly to the battery. You can attach the power cable to an accessory or power buss, however you may have problems with electrical interference. Therefore, it's safer to go ahead and attach the power cable directly to the battery. If the cable is not long enough, splice #18 gauge wire onto it. The power cable has two wires, red and black. Red is the positive lead, black is negative or ground. Make certain to attach the in-line fuse holder to the red lead as close to the power source as possible. For example, if you have to extend the power cable to the battery or power buss, attach one end of the fuse holder directly to the battery or power buss. This will protect both the unit and the power cable in the event of a short. Use a 3-amp fuse.

IMPORTANT!

Do not use this product without a 3-amp fuse wired into the power cable! Failure to use a 3-amp fuse will void your warranty.

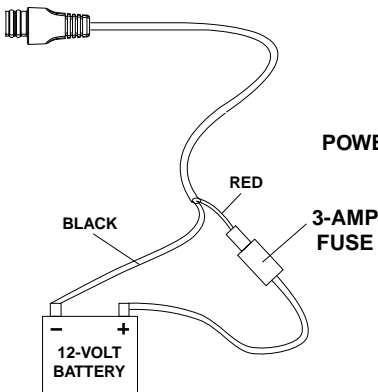

AccuMap POWER CONNECTIONS

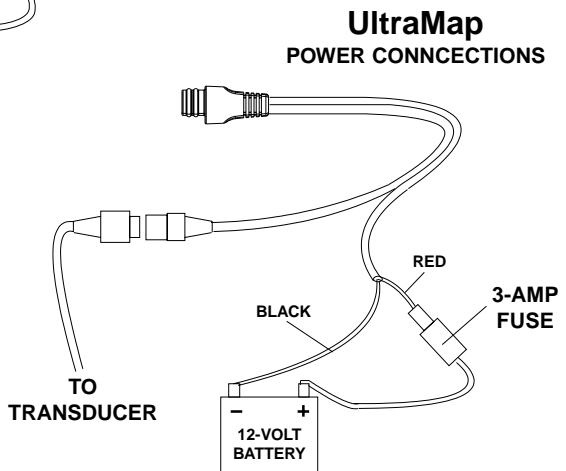

If possible, route the unit's power cable and transducer cable away from other wiring. VHF radio antenna cables radiate noise when transmitting, so be certain to keep the sonar's wires away from it. You may need to route the sonar unit's power cable directly to the battery to isolate it from other wiring on the boat.

CABLE CONNECTIONS - AccuMap Only

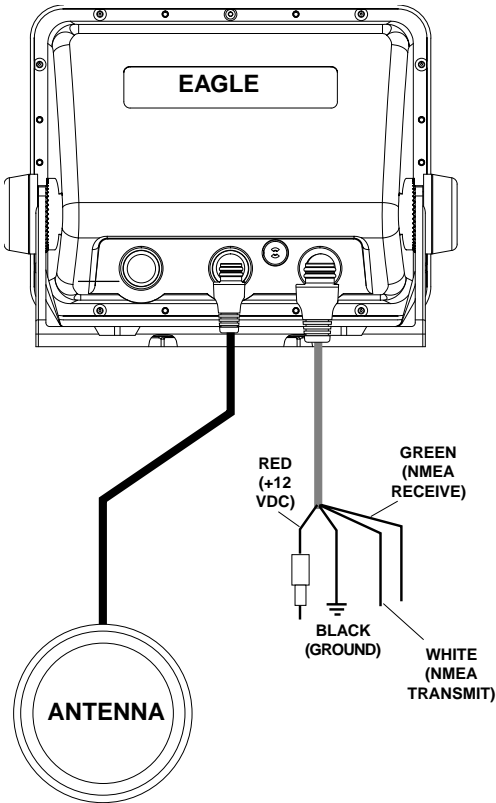

CABLE CONNECTIONS - ULTRAMAP Only

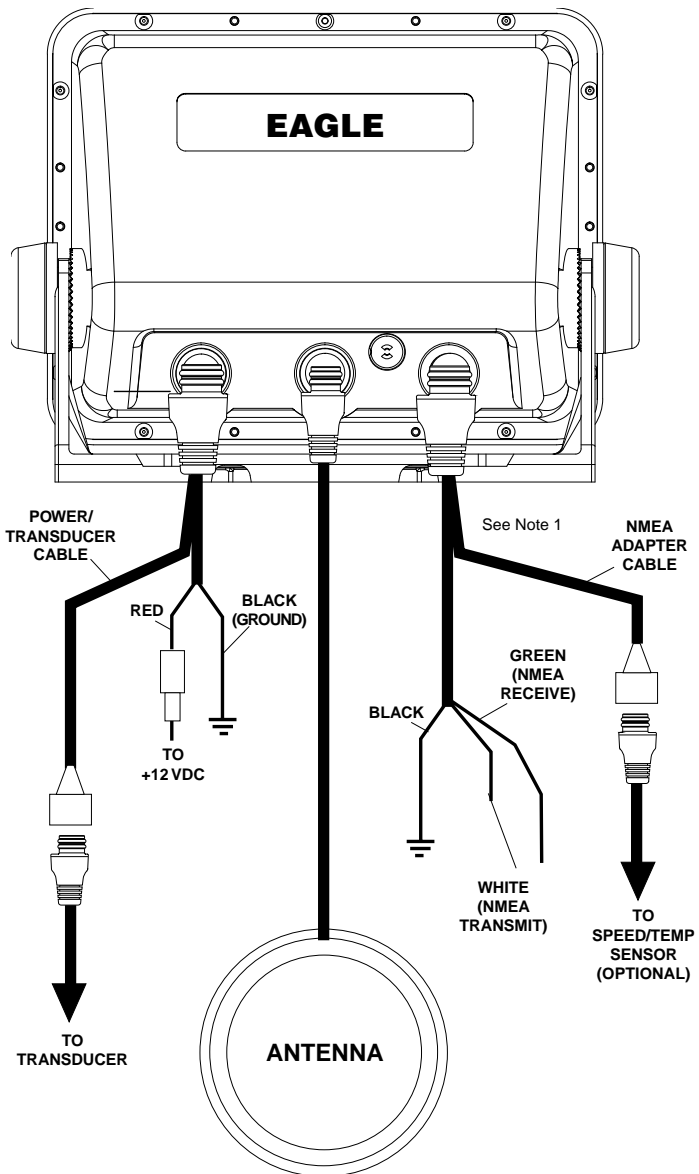

Notes

1. If the NMEA wires are not used, then the NMEA adapter cable is not required. The speed/temperature sensor's cable can be attached directly to the UltraMap.

GPS Antenna Installation - All Units

The antenna can be mounted on any flat surface, provided you have access behind the surface for the mounting screws. A magnet is also supplied that can be epoxied to the bottom of the antenna. A pole mount adapter lets you mount the antenna on a pole or swivel mount that uses standard 1" - 14 threads. The antenna has 25 feet of cable. Do not cut or splice this cable.

Surface Mount

The antenna can be easily installed on any flat surface that is at least 90 mm (3 1/2") wide. Make certain that a clear view of the sky is available at the selected location. Since the GPS signals travel "line-of-sight", nearly anything blocking the antenna can potentially obstruct the unit from finding a satellite. Do not mount it in front of radar antennas. They radiate high energy that can interfere with the GPS signal.

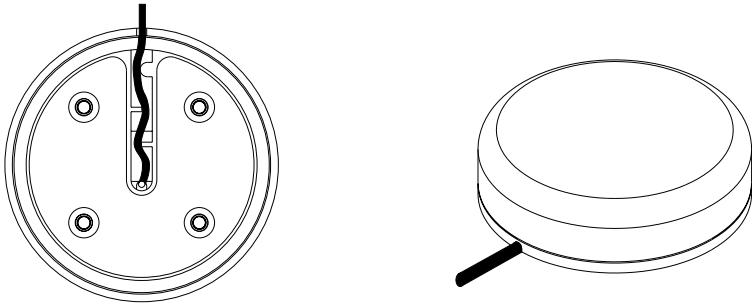

Once you've determined the mounting location, use the template on page 51 in this manual to drill the holes for the screws. The screws, supplied with this antenna, are 4mm x 30mm. (about 1 1/8" long). Drill 4.75 mm (3/16") holes for the mounting screws. If you route the cable through the mounting surface, you'll need to drill a 25 mm (1") hole for the cable.

There is a notch in the antenna housing that allows the cable to pass through to the outside, instead of routing it through the mounting surface. After drilling the holes, pass the o-ring over the antenna cable and press it into the groove on the bottom of the antenna housing. Now attach the antenna to the mounting surface, using 4mm screws and the supplied lock washers. Route the cable to the GPS receiver and the antenna installation is finished.

Magnet Mount

A magnet lets you temporarily mount the antenna on any ferrous metal surface. (such as a car) To use the magnet, simply epoxy it to the bottom of the antenna, using the epoxy supplied with your antenna. Carefully follow the instructions on the epoxy package and apply it to the magnet. Then carefully press the magnet to the bottom of the antenna housing. After the epoxy cures (in about 30 minutes), the antenna is ready for use.

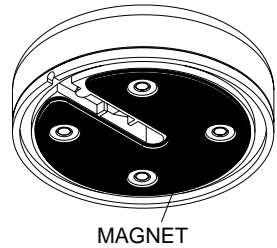

Pole Mount

The antenna attaches to the pole mount adapter with the supplied 4 mm screws. You can route the antenna cable through the slot in the side of the antenna, or pass it down through the pole mount adapter. A slot next to the threads in the pole mount adapter places the cable next to the pole where it can be easily routed down the pole to the GPS receiver. The threads on the pole mount adapter accept a standard marine antenna mount.

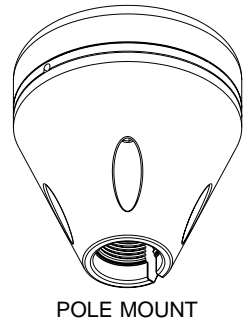

SPEED/TEMPERATURE SENSOR (UltraMap Only)

If you're installing a temperature or speed/temperature sensor, read the sensor's mounting instructions before making the installation. Route the sensor's cable directly to the UltraMap and plug it into the connector on the NMEA/DGPS cable.

TRANSDUCER INSTALLATION (UltraMap Only)

The HS-WSBK supplied with this unit is a transom mount transducer. It can be installed on any outboard or stern-drive (inboard\outboard) powered boat. It can also be permanently installed inside the boat to "shoot-through" the hull on some fiberglass boats.

The "kick-up" mounting bracket helps prevent damage if the transducer strikes an object while the boat is moving. If the transducer does "kick-up", the bracket can easily be pushed back in place without tools.

Read this section carefully before attempting the installation. Determine which of the mounting positions is right for your boat. Remember, the transducer location is the most critical part of a sonar installation.

Location - General

1. The transducer must be placed in a location that has a smooth flow of water at all times. If the transducer is not placed in a smooth flow of water, interference will show on the sonar's display in the form of random lines or dots whenever the boat is moving.
2. The transducer should be installed with its face pointing straight down, if possible.
3. Make certain the transducer's location doesn't interfere with the trailer or hauling of the boat. Also, don't mount it closer than approximately one foot from the engine's lower unit. This will prevent cavitation interference with the propeller. Typically, the transducer should be mounted as deep in the water as possible. This increases the chance that it will be in the water in high speed and reduces the possibility of air bubble interference.

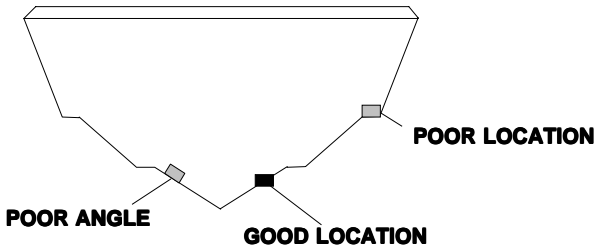

4. If possible, route the transducer cable away from other wiring on the boat. Electrical interference from VHF radio, engine wiring, bilge pumps, and areators can be displayed on the sonar's screen. Use caution when routing the transducer cable around these wires.

CAUTION!
CLAMP THE TRANSDUCER CABLE TO TRANSOM NEAR THE TRANSDUCER. THIS WILL HELP PREVENT THE TRANSDUCER FROM ENTERING THE BOAT IF IT IS KNOCKED OFF AT HIGH SPEED.

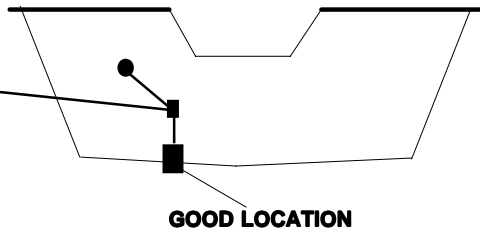

Transducer Assembly and Mounting

The best way to install this transducer is to loosely assemble all of the parts first, then place the transducer's bracket against the transom and see if you can move the transducer so that it's parallel with the ground.

1. Press the two small plastic ratchets into the sides of the metal bracket as shown below. Notice there are letters molded into each ratchet. Place each ratchet into the bracket with the letter "A" aligned with the dot stamped into the metal bracket. This position sets the transducer's coarse angle adjustment for a fourteen (14) degree transom. Most out-board and stern-drive transoms have a fourteen degree angle.

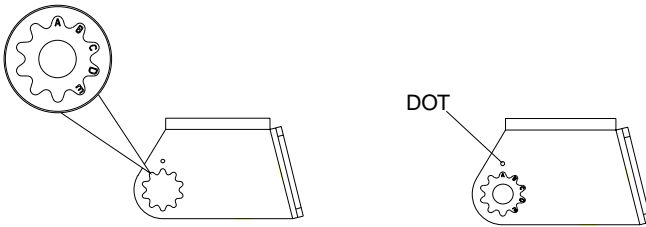

2. Slide the transducer between the two ratchets. Temporarily slide the bolt through the transducer assembly and hold it against the transom. Looking at the transducer from the side, check to see if it will adjust so that its face is parallel to the ground. If it does, then the "A" position is correct for your hull. If the transducer's face isn't parallel with the ground, remove the transducer and ratchets from the bracket. Place the ratchets into the holes in the bracket with the letter "B" aligned with the dot stamped in the bracket. Reassemble the transducer and bracket and place them against the transom. Again, check to see if you can move the transducer so it's parallel with the ground. If it does, then go to step 3. If it doesn't, repeat step 2, but use a different letter until you can place the transducer on the transom correctly.

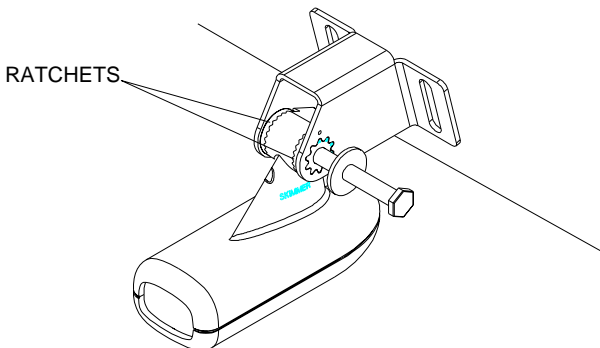

3. Once you determine the correct position for the ratchets, assemble the transducer as shown below. Don't tighten the lock nut at this time.

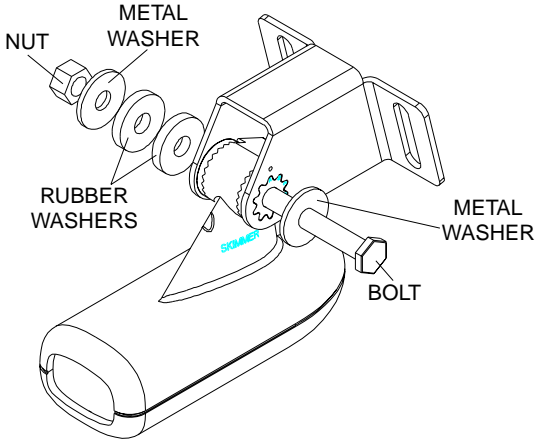

4. Hold the transducer and bracket assembly against the transom. The transducer should be roughly parallel to the ground. The bottom of the transducer bracket should be in line with the bottom of the hull. Don't let the bracket extend below the hull! Mark the center of the slots for the mounting holes. Drill two 5/32" holes in the marked locations for the #10 screws supplied with the transducer.

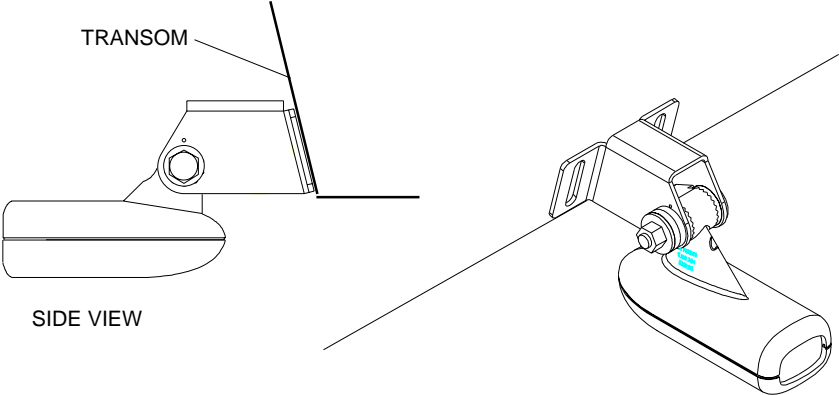

5. Attach the transducer to the transom. Slide the transducer up or down until it's aligned properly on the transom as shown above. Tighten the bracket's mounting screws. Adjust the transducer so that it's parallel to the ground and tighten the lock nut until it touches the flat washer, then add 1/4 turn. Don't over tighten the lock nut! If you do, the transducer won't "kick-up" if it strikes an object in the water.

6. Route the transducer cable to the sonar unit. If possible, route the transducer cable away from other wiring on the boat. Electrical noise from the engine's wiring, bilge pumps, VHF radio wires and cables, and aerators can be picked up by the sonar. Use caution when routing the transducer cable around these wires.

IMPORTANT!

Clamp the transducer cable to the transom close to the transducer. This can prevent the transducer from entering the boat if it is knocked off at high speed.

7. Make a test run to determine the results. If the bottom is lost at high speed, or if noise appears on the display, try sliding the transducer bracket down. This puts the transducer deeper into the water, hopefully below the turbulence causing the noise. Don't allow the transducer bracket to go below the bottom of the hull!

Periodically wash the transducer's face with soap and water to remove any oil film that may collect. Oil and dirt on the face will reduce the sensitivity or may even prevent operation.

INTRODUCTION TO GPS

The Global Positioning System (GPS) was developed by the United States Department of Defense as a 24-hour a day, 365 days a year global navigation system for the military. Civilian availability was added (but with less accuracy) using the same satellites. Twenty-four satellites orbit the Earth. Three of these satellites are spares, unused until needed. The rest virtually guarantee that at least four satellites are in view nearly anywhere on Earth at all times.

The system requires three satellites in order to determine a position. This is called a 2D fix. It takes four satellites to determine both position and elevation, (your height above sea level - also called altitude.) called a 3D fix.

Remember, the unit must have a clear view of the satellites in order to receive their signals. Unlike radio or television, GPS works at very high frequencies. The signals can be blocked easily by trees, buildings, even your body.

Never use this GPS receiver while operating a vehicle!

Like most GPS receivers, this unit doesn't have a compass or any other navigation aid built inside. It relies solely on the signals from the satellites

to calculate a position. Speed, direction of travel, and distance are all calculated from position information. Therefore, in order for it to determine direction of travel, you must be moving and the faster, the better. This is not to say that it won't work at trolling speeds - it will. There will simply be more "wandering" of the data shown on the display.

Another factor that greatly influences the receiver's ability to determine position is SA. The United States government intentionally degrades the satellite's signal for civilian users. They introduce small errors into the signals that makes the GPS receiver less accurate. These errors are called selective availability, or SA. How bad is it? They guarantee that the position reported by a GPS receiver that meets their specifications is within 100 meters horizontally and 150 meters vertically 95% of the time. (The position can be worse than that the other 5% of the time.) In other words, the position shown on your receiver is within 100 meters of your actual position, 95% of the time. That's over 300 feet! Not exactly pinpoint accuracy, but then few people need positioning accuracy greater than this. However, if you do want better performance, (and who doesn't?) many manufacturers (including Eagle) sell a DGPS receiver that attaches to your GPS receiver. The DGPS system transmits correction signals that nullify the effects of SA. The DGPS receiver takes signals from these land-based transmitters and gives them to the GPS receiver which then uses them to show a more accurate position. The ironic part is the federal government implemented SA and is also operating many DGPS transmitters. (You can use the signals from all of the Coast Guard DGPS stations for free, by the way.) The downside to this is it requires another piece of electronic gear (the DGPS receiver) . And you have to be close enough to a station to receive the DGPS signals.

Generally, you find that using your GPS receiver without DGPS is both easy and amazingly accurate. It's easily the most accurate method of electronic navigation available to the general public today. Remember, however, that this receiver is only a tool. Always have another method of navigation available, such as a chart or map and a compass.

Also remember that this unit will always show navigation information in the shortest line from your present position to a waypoint, regardless of terrain! It only calculates position, it can't know what's between you and your camp, for example. It's up to you to safely navigate around obstacles, no matter how you're using this product.

GPS OPERATION

There are 12 keys on the keyboard. You can navigate through the menus, adjust the chart's cursor, and enter data using the arrow keys. The five major modes of operation are accessed using the PAGES key. Press the MENU key to select or adjust a feature from a list. The Z-IN and Z-OUT keys zoom-in or zoom-out the view on the plotter screen. The ENT and EXIT keys are used to enter or clear data or screens. Save and edit waypoints using the WPT key. The PWR key turns the unit on and off. Pressing it once while the unit is operating turns on the screen's back-light. To prevent an accidental shutdown, you must hold the PWR key down for a few seconds to turn the unit off.

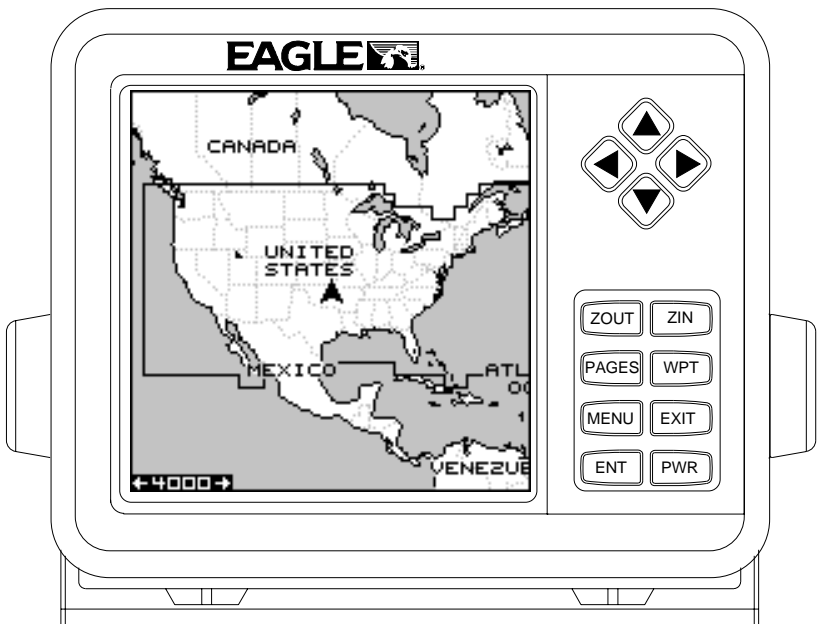

Most of the unit's features are found on "menus". You can view the menus by pressing the MENU key. This product has "Intelligent Menus". There are many menus that pertain to only the sonar, for example. When you press the MENU key and the sonar is showing, menu items for the sonar show in addition to the normal menus. For example, if the sonar is showing, and you press the MENU key, GPS map items won't show on the list. This helps you find the needed item without scrolling through unnecessary menus.

To turn the unit on, simply press the PWR key. A GPS logo screen appears, then the screen similar to the one at right appears. Read the message on the screen, then press the EXIT key to erase it or wait a few seconds and it automatically clears. The screen shown below appears next.

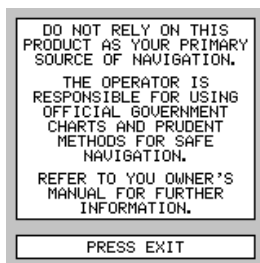

This screen appears each time you turn the unit on. It shows a graphical view of the satellites that are in view. Each satellite is shown on the circular chart relative to your position. The point in the center of the chart is directly overhead. The small inner ring represents 45° above the horizon and the large ring represents the horizon. North is at the top of the screen. You can use this to see which satellites are obstructed by obstacles in your immediate area if you hold the unit facing north.

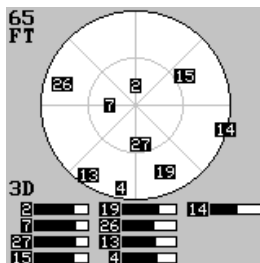

The GPS receiver is tracking satellites that are surrounded by a black box. The receiver hasn't locked onto a satellite if it's number isn't surrounded by a box, therefore it isn't being used to solve the position.

Beneath the circular graph are the bar graphs, one for each satellite in view. Since the unit has twelve channels, it can dedicate one channel per visible satellite. Therefore, if only six satellites are visible, only six bar charts show at the bottom of the screen. The wider the bar on the graph, the better the unit is receiving the signals from the satellite.

The number in the upper left corner is the “expected horizontal position error” or expected error from a benchmark location. In other words, if the expected error shows 50 feet, then the position shown by the unit is estimated to be within 50 feet of the actual location. However, this number is only valid if you're using DGPS or if S/A is turned off. Due to S/A, the accuracy can only be less than 100 meters, 95% of the time, per U.S. government specifications. Although the expected error is not accurate unless you have a DGPS receiver, it does give you an indicator of the fix quality the unit currently has. The smaller the expected error number, the better (and more accurate) the fix is. If the expected error flashes, then the unit hasn't locked onto the satellites, and the number shown isn't valid.

A light bulb indicator at the top right corner of the screen appears when the backlights are on.

FINDING YOUR POSITION

Auto Search

To lock onto the satellites, the GPS receiver needs to know its current position, UTC time, and date. (Elevation (altitude) is also used in the equation, but it's rarely required to determine a position.) It needs this data so that it can calculate which satellites should be in view. It then searches for only those satellites. When your GPS receiver is turned on for the first time, it doesn't know what your position or elevation (altitude) is. It does know the current UTC time and date since these were programmed into it at the factory and an internal clock keeps the time while the unit is turned off. It begins searching for the satellites using the above data that it acquired the last time it was turned on. This probably was at the factory. Since it's almost certain that you're not at our factory, it's probably looking for the wrong satellites. If it doesn't find the satellites it's looking for after five minutes, it switches to Auto Search. The receiver looks for any satellite in the sky. Due to advanced technology, the auto search time has shrunk to about five minutes, so the longest time you should ever have to wait is ten minutes from the time you turn the unit on until it locks onto the satellites and shows a position. Once the unit locks onto the satellites, it should take less than a minute to find your position the next time it's turned on, provided you haven't moved more than approximately 100 miles from the last location it was used.

Manual Initialization

If you don't want to wait for the Auto Search, then you may be able to speed up the initialization process by using the manual initialization feature. Using this feature tells the unit its approximate position. Once it knows its location, it determines exactly which satellites should be in view and starts looking only for those satellites.

To manually initialize the unit, press the MENU key. Now press the down arrow key until the "GPS SETUP" label is highlighted. Press the right arrow key. The "INITIALIZE GPS" label is highlighted. Press the right arrow key again. A screen similar to the one at right appears. Use the arrow keys to move the crosshairs to your approximate location on the map. You can use the ZIN and ZOUT keys to enlarge the map which makes it easier and faster to find your location. The box at the top of the screen shows the latitude and longitude of the cursor position, along with the distance and bearing from the last known position. Once you have the crosshairs on your location, press the ENT key. The unit returns to the satellite status screen.



Using the manual initialization method loads a position that's close to yours into the GPS receiver. It should now have position, time, and date, thereby giving it the data it needs to determine which satellites are in view. Once the satellites are known, the receiver searches for only those satellites, making a lock faster than an auto search method.

All position and navigation data flashes until the unit acquires a position. Do not rely on any data that is flashing! When the numbers are flashing, they represent the last known values when the unit lost its lock on the satellites.

Position Acquisition

When the receiver locks onto the satellites and calculates a position, it shows the message "Position Acquired" on the screen. Once the unit has acquired the satellites and the position acquired message appears, it's ready for use.

(Note: The altitude data may still flash even if the unit shows a "Position Acquired" message and all other data is not flashing. The unit must be locked onto at least four satellites to determine altitude. It only takes three satellites to determine position. You can navigate with this unit if the altitude is flashing, simply ignore the altitude display until it quits flashing.)

REMEMBER, DO NOT NAVIGATE WITH THIS UNIT UNTIL THE NUMBERS STOP FLASHING!

MODES

The UltraMap has five modes: status, navigation, sonar, map, and window groups. The AccuMap has four - no sonar mode. Use the PAGES and arrow keys to switch between the different screens. The four GPS screens that show by default are shown at the top of the next page. (UltraMap owners, see the sonar section in this manual for sonar operation.)

To change modes, simply press the PAGES key. A screen similar to the one at right appears. Use the up or down arrow keys to change modes. (The windows mode is shown as "groups". Group "A" is the first windows group.)

Press the right arrow key while the above menu is showing to switch between different versions of each mode. When the desired screen appears, press the EXIT key to erase the menu.



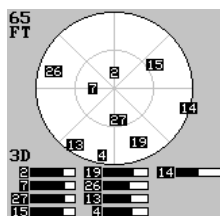

STATUS



NAVIGATION

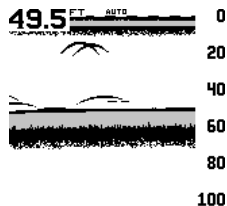

**SONAR
(UltraMap Only)**



MAPPING

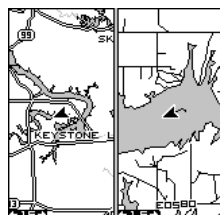

WINDOW GROUPS

Navigation

There are two different navigation screens. Nav screen number one shows a graphical view of your trip, Nav screen number 2 shows all navigation details in large digital numbers. You can also customize both navigation screens to show data other than the default. See the “Programming Boxes” section for more information.

Nav-1

This screen has a compass rose that shows not only your direction of travel, but also the direction to a recalled waypoint. The navigation screen looks like the one at right when you’re not navigating to a waypoint. Your position is shown by an arrow in the center of the screen. Your trail history, or path you’ve taken is depicted by the line extending from the arrow. The arrow pointing down at the top of the compass rose indicates the current track (direction of travel) you are taking. This is also shown in the “TRK” (track) box in the upper right corner of the screen. On the example shown at right, the track is 240°. The current ground speed (GS) shows in the box in the lower center of this screen.

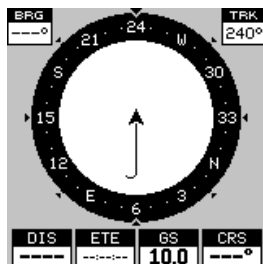

When navigating to a waypoint, Nav screen number one looks like the one at the top of the next page. Bearing to the destination waypoint is in the box in the upper left corner. Bearing is also shown by the large arrow

pointing up towards the compass, above the present position arrow. Distance from the present position to the waypoint (DIS) shows beneath the compass on the lower left side of the screen. Next to the distance box is estimated time enroute (ETE). This is the estimated time that it will take you to arrive at the destination, based upon current track and ground speed. In the lower right corner is the course (CRS) box showing the direction from your starting position to the waypoint. Remember, a course is a proposed path from the starting position to the destination. Track is your actual direction of travel.



Lines on either side of the present position show the current cross track error range. Cross track error is the distance you are off-course to the side of the desired course line. The course line is an imaginary line drawn from your position when you started navigating to the destination waypoint. It's shown on the screen as a vertical dotted line. The default for the cross track error range is 0.20 mile. For example, if the present position symbol touches the right cross track error line, then you are .25 mile to the right of the desired course. You need to steer left to return to the desired course. You can use the ZIN or ZOUT keys to change the cross track error range. A circle depicting your destination (waypoint) appears on the screen as you approach the waypoint as shown on the screen at right.



Nav-2

This navigation screen shows all navigation information in large digital numbers. To view this screen, press the PAGES key, then press the up arrow key until the "NAV 1" label is highlighted. While it's highlighted, press the right arrow key. The screen shown at right appears. Press the EXIT key to erase the menu.

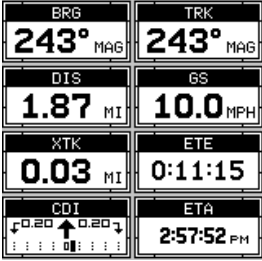

This screen is composed of eight digital boxes. Track (TRK) and ground speed (GS) data are the only ones that show data if you're not navigating to a waypoint. If you are navigating to a waypoint, then bearing (BRG), distance to waypoint (DIS), estimated time enroute (ETE), cross track error (XTK), estimated time of arrival (ETA), and the CDI also operate.

Course Deviation Indicator (CDI)

Once navigation to a waypoint is established, the CDI shows your distance to the left or right of the desired course. The vertical line in the box shows both the direction you must steer to get back on course and the distance to the course line. For example, if you're travelling straight towards the destination, from the start, then the line stays in the center. If you drift off course to the right, the line moves to the left. This signifies that you need to steer to the left to get back on course. This is called "chasing the needle". If you steer towards the line (needle), you'll always be heading in the correct direction to get back on course.

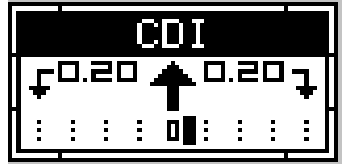

The CDI's range shows beneath the CDI label. On the above screen, the CDI range is .20 mile, which is the default. You can adjust the range by selecting "ALARMS" on the main menu, then "GPS ALARMS". Highlight the "CDI DIS" label, then use the left or right arrow key to adjust it. The CDI range is also shown by the dotted lines at the far left and right side of the CDI indicator. If the solid line is on either of the dotted lines, then you are 0.20 mile off course. Remember, if the line moves to the left, then you are too far to the right of the desired course line and vice-versa.

Using the CDI with a mapping screen helps you visualize your position in relation to the course. The screen on the right shows that we are off course to the right. The vertical bar has moved to the left side of the CDI, showing the direction to the desired course line. The CDI gives you a quick, easy to read visual indicator of your relationship between your direction of travel and the desired direction.

Map

This unit has a ground map of the world built inside. This map has the majority of its detail in far southern Canada, the continental United States and Hawaiian islands, northern Mexico, the Bahamas, and Bermuda. The map screens show your course and track from a "birds-eye" view. If you're navigating to a waypoint, the map shows your starting location, present position, course line, and destination. You don't have to navigate to a waypoint, however, to use the map.

Using the map is as simple as pressing the PAGES key, then highlighting "MAP 1". A screen similar to the one at right appears. The arrow flashing in the center of the screen is your present

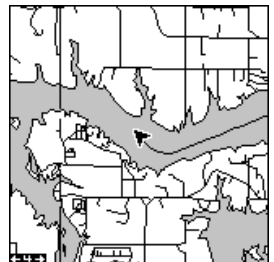

position. It points in the direction you're travelling. The solid line extending from the arrow is your plot trail, or path you've taken. The plotter's range shows in the lower left corner of the screen. In this example, the plotter's range is four miles from the left edge of the map to the right.

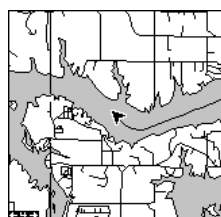

MAP-1

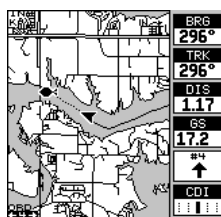

MAP-2

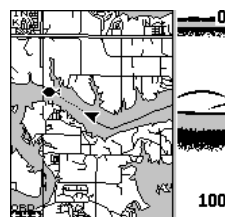

MAP-3

There are three different mapping screens. To view the other map screens, press the PAGES key, highlight the MAP label, and press the right arrow key until the desired map screen appears. Press the EXIT key to erase the menu. Map-2 has navigation data added at the right side. The data includes bearing to waypoint (BRG), track (TRK), distance to waypoint (DIS), ground speed (GS), a steering arrow (shows the direction to the destination when the top of the screen is pointing in your direction of travel), and a CDI.

Map-3 is similar to Map-2, except it shows sonar data on the right side. When the MENU key is pressed while Map-3 is showing, the screen shown at right appears. The "ACTIVE MODE" menu at the top of this screen lets you switch the arrow and zoom keys between the GPS side and the sonar side of Map-3.



The Z-IN and Z-OUT keys zoom-in and out all maps to enlarge or reduce their coverage area. The available ranges are: 0.1, 0.15, 0.2, 0.3, 0.4, 0.6, 0.8, 1, 1.5, 2, 3, 4, 5, 6, 8, 10, 15, 20, 30, 40, 60, 80, 100, 150, 200, 300, 400, 600, 800, 1000, 1500, 2000, 3000, and 4000 miles.

Cursor

Pressing an arrow key turns on two dotted lines that intersect at the present position symbol. These lines are called a "cursor" and have a variety of uses.

To turn the cursor on, simply press the arrow key in the direction you want the cursor to move. This lets you view areas on the plotter that are away

from your present position. The zoom-in and zoom-out keys work from the cursor's position when it's active - not the present position. You can zoom in on any detail, anywhere. The cursor can also place icons and waypoints.

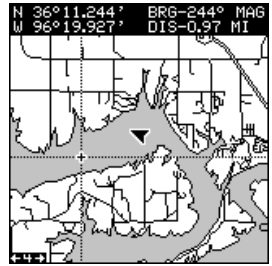

When the cursor is used with map-1, its position, bearing, and distance from your present position show at the top of the screen.

Cursor Distance

You can use the cursor to find the distance between two points. While the cursor is showing, press the MENU key, then select "FIND DISTANCE". The unit returns to the mapping screen. Now move the cursor to the first location that you want to measure the distance from and press the ENT key. Now move the cursor to the position that you want to measure the distance to. A line is drawn from the point when the ENT key was pressed to the cursor's present location. The distance covered by the line shows at the top of the screen. To measure another two points, simply move the cursor and press the ENT key.

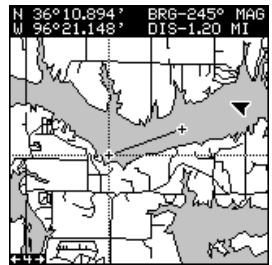

Press the EXIT key to erase the cursor. The unit centers your present position on the screen after erasing the cursor.

MAP SETUP

The map has many customization options. To change them, first press the MENU key while a map is showing on the screen. The map setup label is highlighted. Press the right arrow key. A screen similar to the one at right appears.

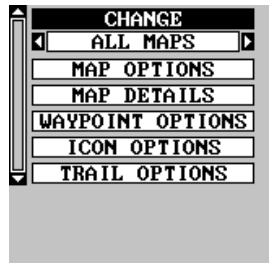

Change Maps

Changes made to the map using the options in the Map Setup is normally made to all map screens. The change can be limited to the map screen currently in use, however, by switching the "All Maps" to "This Map" in the "Change" menu. To do this, simply highlight the "Change" label, then press the right arrow key. To switch back, repeat the above.

Map Options

The following map options are listed under the “Map Options” menu: Map Orientation, Auto Zoom, Range Rings, and Latitude/Longitude Grids.

Map Orientation

By default, this receiver shows the map with north always at the top of the screen. This is the way most maps and charts are printed on paper. This is fine if you're always travelling due north. What you see to your left corresponds to the left side of the map, to your right is shown on the right side of the map, and so on. However, if you travel any other direction, the map doesn't line up with your view of the world.

To correct this problem, a track-up mode rotates the map as you turn. Thus, what you see on the left side of the screen should always be to your left, and so on. A course-up mode keeps the map at the same orientation as the initial bearing to the waypoint.

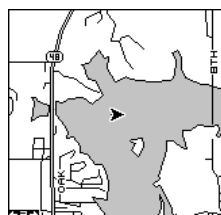

NORTH-UP

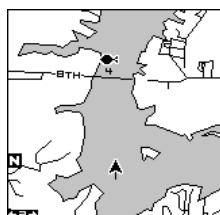

TRACK-UP

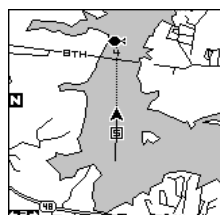

COURSE-UP

In the north-up view shown at left, we're travelling east. In this view, the present position indicator appears to move towards the right side of the screen.

In the track-up view, the present position moves straight towards the top of the display. A “N” shows to help you see which direction is north when the track-up mode is on. Remember, in the track-up mode, the screen rotates as you change direction. It always keeps your direction of travel (track) heading towards the top of the screen.

In the course-up mode, the screen is locked into your original bearing to the recalled waypoint, regardless of your track.

To select the desired mode, first press the MENU key, select “MAP 1 SETUP”, then select “MAP OPTIONS”. Finally, select “ORIENTATION” and press the right or left arrow key until the desired mode appears. Press the EXIT key to erase this menu.

Range Rings/Grid Lines

The map screen can be customized with rings that are 1/4 of the range and/or grids that divide the plotter into equal segments of latitude and longitude. To do this, press the MENU key, select "Map 1 Setup", then "Map Options". Highlight the desired option, then press the right arrow key to turn it on. Press the EXIT key repeatedly to erase the menus. The screen at right shows grids.

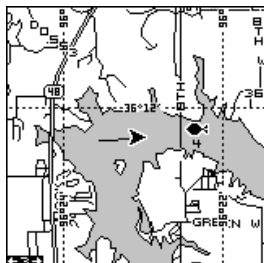

AUTOZOOM

This receiver has an autozoom feature that eliminates much of the button pushing that competitive units force you to make. It works in conjunction with the navigation features. First, recall a waypoint. (See the waypoint section for more information on navigating to a waypoint.) Then, with the autozoom mode on, the unit zooms out until the entire course shows, from the present position to the destination waypoint (recalled waypoint). As you travel towards the destination, the unit automatically begins zooming in, one zoom range at a time, keeping the destination on the screen.

The screens below show a slice of the progression of a trip near a lake. Screen number one is the start and is on the 3 mile range. Intermediate stages progressively zoom in as it gets closer to the destination.



1

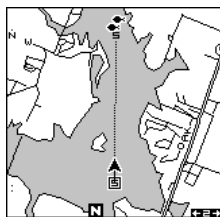

2

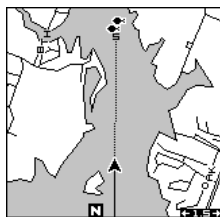

3

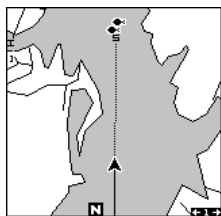

4

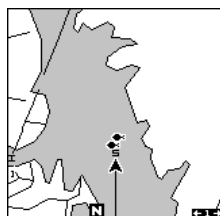

5

MAP DETAILS

This unit lets you change many of the built-in background map's features. To change the options, first press the MENU key, then select the Map Details label. Press the right arrow key. The screen shown at right appears.



Earth Map On/Off

The map can be turned on or off using the "All Map Details" label. Simply highlight the menu, then press the left arrow key to turn it off.

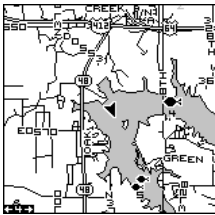

EARTH MAP ON

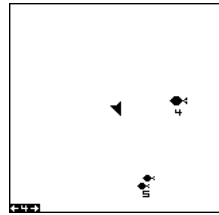

EARTH MAP OFF

Text Labels

Select "Map Text" to turn all names on the map (such as Lake Tahoe or Mississippi River) off or on. The default is "on". Press the left arrow key to turn them off.

Map Detail

The detail shown on the background map diminishes as the screen is zoomed out. This prevents cluttering of the display, or overlapping of text and graphics which can make it unreadable. There are two detail levels: normal and high. The difference between the two shows below. The screen on the left is normal detail, on the right is high detail. Both screens are on the 10 mile range.

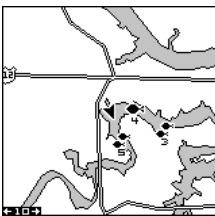

NORMAL DETAIL

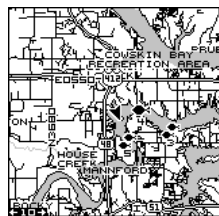

HIGH DETAIL

To change the map's detail setting, select "Map Detail Level" from the map details menu, then press the right arrow key.

Gray Fill

When this unit is first turned on, all water (lakes, oceans, rivers) is filled with gray to distinguish it from land, which is clear. (See below) To make the land fill with gray and water remain clear, select the "Fill with Gray" label from the Map Detail menu, then press the left arrow key. Press the EXIT key repeatedly to return to the mapping screen.

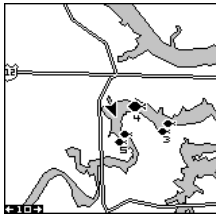

**WATER FILLED
WITH GRAY**

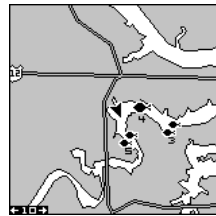















**LAND FILLED
WITH GRAY**

Map Boundaries

By default, this unit draws a line around areas of the map that have more detail than the background map. This line depicts the detailed map boundaries. To turn this off, select "Map Bounds" from the map details menu, then press the left arrow key.

Map Symbols

When the nav aid data is downloaded to this unit, buoys and other navigational aids can be turned off or on by using "Map Symbols" on the "Map Details" menu. To find this menu, press the down arrow key while on the "Map Details" menu until "Map Symbols" appears. Press the left arrow key to turn them off.

	LIGHTED BUOY		INTERSTATE HIGHWAY
	UNLIGHTED BUOY		U.S. ROUTE HIGHWAY
	LIGHT		U.S. ALTERNATE ROUTE HWY.
	SQUARE DAYBEACON		STATE HIGHWAY
	TRIANGLE DAYBEACON		COUNTY ROUTE
	RADIO BEACON		TRANS-CANADA HIGHWAY
	PLATFORM		CANADIAN (QUEBEC) AUTOROUTE
			MEXICAN FEDERAL HWY.

Locations

Normally, text disappears as you zoom out. This declutters the screen, making it easier to see significant map detail. Turning “LOCATION DOTS” on from the Map Details menu places a dot on the screen where a text label should be when the screen is zoomed out.

Contour Lines

Some nav aid data shows depth contour lines in navigable waters. To turn these lines off, select “Contour Lines” from the “Map Detail” menu. Press the left arrow key to turn them off. Press the EXIT key to erase the menu.

PLOT TRAIL

The line extending from the present position symbol is called a plot trail. You can customize the plot trail and save trails using the trail options menu. To use it, press the MENU key, select “MAP SETUP”, then “TRAIL OPTIONS”. The screen at right appears.



Clear Trail

To erase the current plot trail from the screen, select Clear Trail from the Trail Options menu. A message appears, asking if you really want to erase the plot trail. Follow the instructions on the screen. When the trail is erased, the unit returns to the map screen.

Flash Trail

By default, the plot trail flashes once per second. This typically makes it easier to see the plot trail against the background map. To turn the flashing off, select “FLASH TRAIL” from the trail options menu. Press the left arrow key to turn it off.

Trails Shown

The current plot trail shows on the map by default. To place a previously saved trail onto the plotter, choose “TRAILS SHOWN” from the Trail Options menu. The screen shown at right appears. Highlight the desired trail on this screen, then press the right arrow key to select it. Press the EXIT key to erase this menu. The selected plot trail shows on the plotter.



Save a Trail

This unit automatically saves the current plot trail in memory when you turn it off. You can save two other trails in memory. To save your current

plot trail in a specific memory location, choose “SAVE TRAIL” from the “TRAIL OPTIONS” menu. A new screen appears. Highlight the desired number that you wish to save the current trail under, (i.e. “Trail 1 or Trail 2) and press the right arrow key. Your current trail is saved. Press the EXIT key to erase this menu.

Update Options

By default, the plotter places a dot on the screen every 3 seconds to create the plot trail. You can change this time from once per second to once every thirty minutes. The plot trail can also be updated by distance instead of by time. The distance update rate can be set from 0.01 to once every 10 miles.



From the trail options menu, choose “UPDATE OPTIONS”. Select “UPDATE TRAIL BY” to change the update from time to distance. To change the rate or distance, simply select either the “UPDATE RATE” or “UPDATE DIS” menus as appropriate, use the left or right arrow keys to adjust it, then press the EXIT key to erase the menu.

ICONS

The plotter has 28 symbols or “icons” available that can be placed anywhere on the screen. They can be used to mark fishing or hunting locations, landmarks, boat ramps, and virtually any point of interest. An icon can be placed at your present position or at the cursor’s location.

To place an icon at your present position, simply press the ENT key while the mapping screen is on. The screen shown at right appears. Use the arrow keys to highlight the desired icon. Now press the ENT key again. The mapping screen reappears with the icon showing at the position you were at when the ENT key was pressed. On the screens shown at the top of the next page, the shipwreck icon was placed.

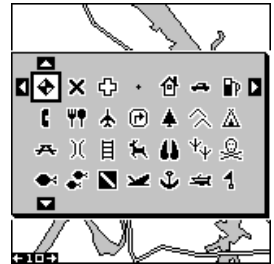

To place an icon at the cursor’s position, first use the arrow keys to move the cursor to the location that you wish to place the icon. Next, press the ENT key. Now select the icon using the arrow keys. While it’s selected, press the ENT key. The map reappears with the icon placed at the cursor crosshairs. Press the EXIT key to erase the cursor.

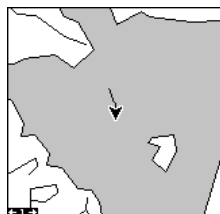

MAP SCREEN
PRESS ENT KEY



SELECT ICON
PRESS ENT KEY

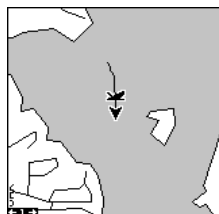

ICON PLACED AT
POSITION

Icons can be erased from the plotter individually, all of a specific type, or all at once. They can also simply be turned off without erasing them. To make changes to the icons, press the MENU key, then select MAP SETUP, and finally select Icon Options. The screen shown at right appears.



The first menu (ICONS OFF/ON) simply turns all icon symbols off or on. This doesn't erase the icons, it simply "hides" the icons from the map. You can use this feature to temporarily de-clutter the display.

The DELETE ALL ICONS selection does erase all of the icons from memory, Use this only if you want to erase all icons that have been placed on all map screens.

To erase only a certain type of icon, select the DELETE ICON TYPE menu. The icon menu appears. Highlight the icon style that you want to erase from memory, then press the ENT key. The unit returns to the map screen with only the selected icons erased.

You can delete individual icons by selecting "DELETE FROM MAP". Once this menu is selected, the unit returns to the mapping screen with the cursor activated as shown at right. Use the arrow keys to move the cursor to the icon that you want to erase. Once the crosshairs are on top of the icon, press the ENT key. The icon is immediately erased. Press the EXIT key to erase the cursor.



MAP DOWNLOADING

This unit has a background map of the world permanently installed inside. You can send an enhanced map from the enclosed CD-ROM to the unit using a personal computer.

Currently, the MapSelect CD has the following databases:

IMS SmartMap™ data covers the 48 contiguous states and are broken down into 64 different mapping regions. Contained in this database are the names and locations of over 140,000 cities; 30,000 national, state and county parks; 120,000 inland bodies of water plus coastal waters out to 25 miles; as well as nearly all state and federal highways, interstates and routes.

IMS WorldMap™ data covers 35 specific regions around the globe including Canada, Europe, Indonesia and Australia. Contained in this database are the names and locations of cities, towns, provinces and states, plus major roadways including two- and four-lane highways, inland waterways and coastal hydrography.

Coastal nav aid data covers coastal regions of the 49 U.S. States (excluding Hawaii), the District of Columbia, the Great Lakes and many large coastal rivers and other large inland lakes. Contained are approximately 60,000 marine navigation aids. Each navigation aid is displayed as a small symbol, with information useful to the navigator (including light type (flashing or continuous), light color, and other aid markings) below the symbol.

To use one of these, install the software from the CD-ROM onto your PC compatible computer according to the instructions supplied with the CD. Next, plug the AC adapter into a wall socket, and attach its cable to the unit. Connect the cable supplied with this unit from a serial port on the computer to the GPS receiver. Now turn the unit on and adjust the communication port baud rate to its highest level (Press MENU/SYSTEM SETUP/COM PORT SETUP). Set the parity to "none" and data bits to "8".

Start the GDM 16 program on the computer. Click on the "GPS" label, then click on "Options". Select the com port that the GPS cable is connected to and click "OK". Now click on the "GPS" label, then "Initialize". This starts the communication between the GPS unit and the computer. If the communications fail, try switching the baud rate on the GPS unit to a lower setting. Once the communications are established, click on the "Map Select" tab. Choose a memory partition to download a map into, then choose a map. If you have problems, click on "Help". There is extensive help available on the GDM-16 program.

TRANSFERRING MAP DATA

Using either GDM or MapCreate software, you may transfer maps of your choice to your GPS Unit. The following instructions are for the GDM software.

1. Click on the MapSelect Tab.
2. Select a map by clicking on the desired database button (IMS Smart-Map, IMS WorldMap, or Coastal Nav aids). A map appears on the screen. Click the desired area that you want to download to the GPS unit.
3. Select a memory partition by clicking on Memory Partition 1 or 2.
(Note: Any data already present in a selected memory partition will be overwritten. When transferring map data larger than 1 megabyte, both memory partitions are automatically selected.)
4. Click the Transfer Map Data Button.

A status bar appears on both the PC and the GPS unit's screen. When the bar disappears, the transfer is complete. You'll be able to see the difference when the unit is zoomed in to ranges of ten miles or less.

WINDOWS

The UltraMap has 13 different data screens chosen for their broad range of navigation information and ease of use. The AccuMap has 10.

To use the windows feature, press the PAGES key, then highlight the "GROUP A" label at the bottom of the screen. Group A is visible in the background when you switch to the windows group. Press the left or right arrow key to switch between all off the groups. When the desired group appears, press the EXIT key to erase the Pages menu. A summary of the groups follows. Note that many of the groups have navigation data that require navigation to a waypoint in order to show data. See the waypoint section for information on setting up the unit for waypoint navigation.

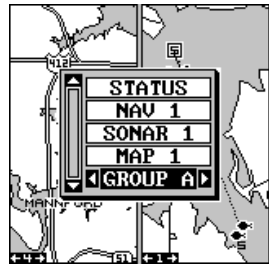

Group A

This screen has two maps. Each map works separately from the other. For example, the left map has a 4 mile range, while the right one is zoomed in to one mile. To zoom in or out on the bottom map, simply press the ZIN or ZOUT keys. The main menu also has selections for the upper map and lower map setups.

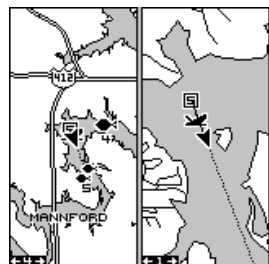

Group B

This screen has a map on the top half with bearing (BRG), distance to go (DIS), track (TRK) and the CDI on the lower half.

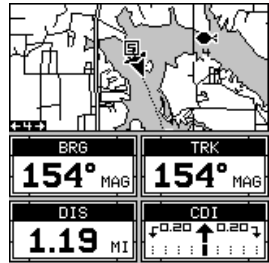

Group C

A half screen map is on the left side of the screen. A quarter-size map is in the upper right corner. Track (TRK) and the CDI shows distance to go (DIS) show in the lower right quarter.

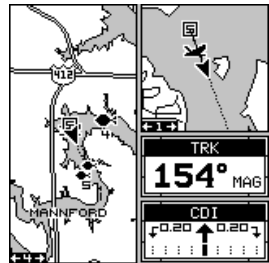

Group D

This group has a half-screen map on the left side of the screen. CDI, bearing (BRG), estimated time en-route (ETE), and ground speed (GS) are on the right side.

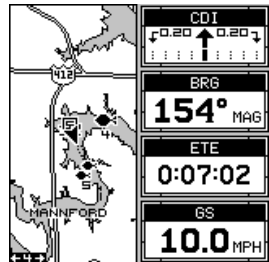

Group E

Digital displays make up this group. It has bearing (BRG), distance to go (DIS), track (TRK), ground speed (GS), CDI, estimated time en-route (ETE), velocity made good (VMG), and altitude (ALT).



Group F - UltraMap Only

This group shows your present position (POSITION) in latitude/longitude at the top of the screen, and in UTM at the bottom. You can change the type of position display on both the top and bottom of this (and all) screens by pressing the MENU key, then selecting "GPS SETUP". Now select "POSITION FORMAT" to change the top position display, or "ALTERNATE FORMAT" to change the bottom display.

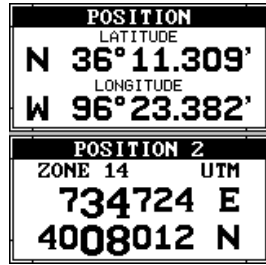

Group G

The group G screen shows DGPS information. There must be a DGPS receiver connected to the unit in order to use this screen.

The DGPS status, station's ID number, frequency, bit rate, signal strength, bit rate, signal to noise ratio (SNR), and time since the GPS receiver received the satellite corrections (AGE) all show in the top half of this screen.



The DGPS corrections at the bottom of the screen shows a list of the satellites in view. The satellite's number is followed by an identifier showing its status. They are as follows:

- OK DGPS corrections are in use by GPS receiver and corrections are available.
- OLD Unit hasn't received corrections in last 60 seconds.
- NA No correction available.

Group H

This is a time screen. An analog clock shows in the top left corner, followed by a digital clock showing your local time on the right. The clock's alarm setting shows in this window, also. UTC time shows at the bottom right corner of this screen. (UTC is the time at the prime meridian. It used to be called GMT.) Battery voltage and estimated time of arrival (ETA) complete this group.

To set the clock alarm, first press the MENU key,

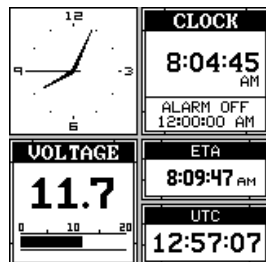

then select "CLOCK ALARM" and press the right arrow key. Now select "SET CLOCK ALARM". The screen at right appears. Using the arrow keys, enter the alarm's time. Press the ENT key. The unit returns to the clock alarm menu. Highlight the "CLOCK ALM OFF ON" label and press the right arrow key to turn it on. Press the EXIT key to erase the menus. The unit returns to group H with the new alarm time in the clock's window.



Group I

This group has a trip timer (TRP TIMER), estimated time enroute (ETE), a digital clock, and estimated time of arrival (ETA). The trip timer measures the total time you have been traveling. It starts counting when you exceed a preset speed. The default is 5 miles per hour. You can adjust this time from zero to 200 m.p.h.. To do this, press the MENU key, then select "TRIP TIMER SETUP" menu. Highlight the "TRIP START GS" label, then press the left or right arrow keys until the desired speed appears. Press the EXIT key to erase this screen.



Group J

There are three timers on this screen and an odometer (TRIP DIS). The trip timer is described in group I.

Trip distance measures the distance you've travelled since it was last reset. To reset the trip meter, press the MENU key, then select "TRIP METER RESET" and press the right arrow key. The unit returns to Group J with the trip meter reset to zero.



The up timer starts at zero and counts up. The up timer also has an alarm. The down timer starts from a user setting and counts down to zero.

To start a timer, first press the MENU key, then highlight the desired timer setup menu. In this example, we're using the count up timer, so the UP TIMER SETUP was selected. Now press the right arrow key. A screen similar to the one at the top of the next page appears. To start the timer, simply highlight the "UP TIMER" menu, then press the right arrow key. To

reset the timer to zero, select the “UP TIMER RESET” menu. The up timer also has an alarm that can be set to sound at a preset time. (For example, one hour from now, three hours, etc.) To set the alarm, highlight the “SET UP TIMER ALM” and press the right arrow key. The screen below right appears.



Using the arrow keys, highlight the first number in the time that you want to set. (The time is in hours, minutes, and seconds) Now press the up or down arrow keys until the desired number shows. Continue until the time shown in the display is correct, then press the ENT key. The unit returns to the timer menu screen. To turn the alarm on, highlight the “UP TIMER ALARM” label. Press the right arrow key. Press the EXIT key to erase the menu. The time you set shows in the “UP TIMER” box . The timer continues counting until you stop it. When it reaches the alarm’s time setting, a tone sounds. Press the EXIT key to shut the alarm off.



The countdown timer starts from a time that you enter and counts down to zero. (Note: When the countdown timer reaches zero, it begins counting up until you press the EXIT key. This tells you how long it’s been since the alarm sounded.) Use the “DOWN TIMER SETUP” menu to adjust the countdown timer and reset it to zero.

Group K (UltraMap Only)

This group has a map on the left half of the screen and sonar on the right. When the MENU key is pressed while Map-3 is showing, the "ACTIVE MODE" menu at the top of the menu lets you switch the arrow and zoom keys between the GPS side and the sonar side of group K.

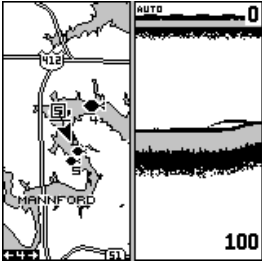

Group L (UltraMap Only)

This group has a digital depth display along with the sonar alarms setting in the upper left corner of the screen. (See the sonar section for more information on the sonar alarms.) A quarter-size sonar screen shows in the upper right corner. Surface water temperature shows in the lower left corner of the screen, both digital and a temperature graph. Water speed and a second temperature show in the bottom right corner of the screen. (Note: Speed and water temperature on this screen display comes from an optional speed/temperature sensor. The TEMP 2 display requires an optional TS-2BK temperature sensor.)

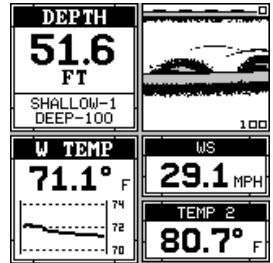

Group M (UltraMap Only)

This screen has digital depth, half-screen sonar, water speed, and surface water temperature displays.

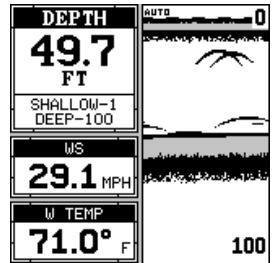

Reprogram Boxes

The digital boxes on MAP 2 and both NAV screens can be reprogrammed, changing the informations shown by the boxes.

To customize a screen, first switch to the screen that you want to customize. Map-2 (shown at right) is used in this example. Next, press the MENU key, then select the "Reprogram Boxes" menu. The screen shown below appears.

This is the MAP-2 edit screen. The "BRG" box near the left corner flashes, which means it's ready for change. If you don't want to change this box, simply press the up or down arrow key to move to the box that you want to change. In this example, we will change the bearing (BRG) box to ground speed (GS). To do this, simply press the left or right arrow key while the box is flashing. The box changes each time the arrow key is pressed. When the desired box appears, then you can change another

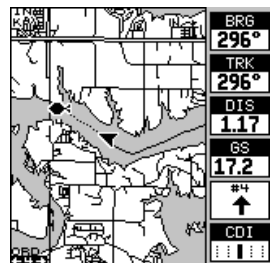

box or save your changes by pressing the ENT key. If you want to leave this screen without saving the changes, simply press the EXIT key. Use this same method to change the NAV screens.

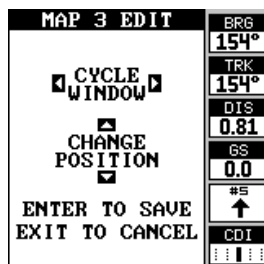

Reset Groups

To restore all boxes on the navigation and plotter screens to their factory settings, first press the MENU key, then highlight the “System Setup” label and press the right arrow key. Now highlight the “Reset Groups” label on this menu. Press the right arrow key. A message appears, asking if you really want to do this. Press the right arrow key to continue, or the left arrow key to exit without resetting the groups.

WAYPOINTS

This GPS receiver gives you the ability to create your own database of locations, called “waypoints”. You can save your present position, cursor position, or enter a coordinate and save it as a waypoint. For example, you may wish to store the location of your parked car as a waypoint before starting on a hike. When you want to return to the car, all you have to do is recall the waypoint and the unit will show distance and bearing from your present position to the car. This unit stores up to 750 waypoints.

Waypoint Menu

With few exceptions, in order to save, modify, or recall a waypoint, you’ll use the waypoint menu, shown at right. To see this menu, simply press the WPT key. The current waypoint number shows at the top of the screen. Its name appears beneath the “GO TO WAYPOINT” label. The waypoint’s position, distance and bearing from your present position to the waypoint, and the date and time the waypoint was saved show at the bottom of the screen. It’s icon shows just to the right of the date and time. In short, all of the detail about the waypoint shows on this screen.



Saving Your Present Position as a Waypoint (Quick Save Method)

To save your present position, simply press the WPT key twice. Your current position is placed into the first available waypoint number on the list. A message appears on the display telling you the waypoint number it just used. This also momentarily places you in the waypoint menu. Anytime

this menu is showing, simply press the WPT key once and the unit will store your present position on the waypoint list.

Saving the Cursor Position as a Waypoint

When the cursor is showing on the map and you press the WPT key twice, the cursor's position is placed into the first available waypoint number. In the example screen shown below, the cursor is placed at the desired location. Pressing the WPT twice causes waypoint number 6 to be placed at the cursor's crosshairs. (Waypoint 6 was the next available waypoint number.) A message appears on the display telling you the waypoint number it just used. Wait a few seconds and the menu will clear automatically. Press the EXIT key to erase the cursor.

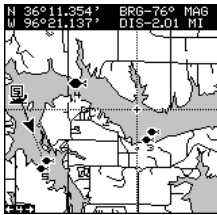

MOVE CURSOR TO DESIRED LOCATION

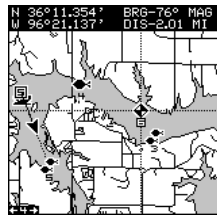

PRESS WPT KEY TWICE

Saving Your Present Position as a Waypoint (Select Number Method)

The method shown previously doesn't let you choose the waypoint number. You can pick the waypoint number, then save your present or cursor position. To save your present position, press the WPT key once. (If you're saving the cursor position, first move the cursor to the desired location, then press the WPT key.) A screen similar to the one on the previous page appears.

Highlight the "WAYPOINT #" label at the top of the screen. Press the right or left arrow keys until the desired waypoint number appears that you wish to save your present (or cursor) location under. Waypoint number 4 is used in this example. Now select "CREATE WAYPOINT". A screen similar to the one at right appears. Finally, highlight "CURRENT POSITION" and press the right arrow key. The unit returns to the waypoint screen with the position saved under the selected waypoint number.



Saving a New Position

To save a position other than the cursor's or the present position as a waypoint, first select the waypoint number as described on the previous page. Next, select "CREATE WAYPOINT". The screen shown at the bottom of the previous page appears. Select "ENTER POSITION". The screen shown at right appears. Using the arrow keys, enter the latitude and longitude of the position that you want to save. (Note: latitude and longitude is the default, however if UTM or other position format is in use, this screen will let you enter the position in the format that's currently in use.)

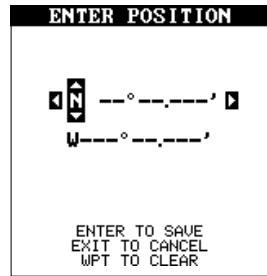

Waypoint Averaging

Although electronic position finding devices such as this one show the position in precise digital numbers, there is some ambiguity in the displayed position. With position pinning turned off, you can see this by watching the position displayed on the unit move while you're standing still. This is due to many factors; SA, atmospheric conditions, the number of satellites being tracked and their location relative to your position, and so on.

However, even with SA turned on, this GPS receiver can show surprisingly accurate position information. If you wish to increase the accuracy of a saved position, use the waypoint averaging method. This method requires the unit to remain untouched at the location that you want to save, preferably for at least one hour. Longer times will result in a better position. The unit averages all of the positions reported by its GPS receiver, resulting in typically higher position accuracy.

To use this feature, first press the WPT key and select a waypoint number, then select "CREATE WAYPOINT". The screen in the middle of the previous page appears. Now select "AVERAGE POSITION". The screen shown at right appears. Your present position shows at the top of the screen. A box with a plotter graphically shows the movement of your average position. The number of positions or points taken appears next to the plotter. The position is updated once per second. Now place the unit where it has an unobstructed view of the sky. At the end of the position gathering time, press the ENT key to save the averaged position.

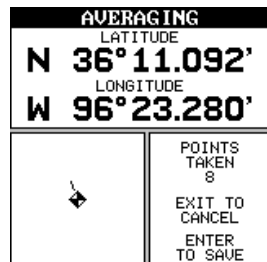

Project Position

You can save a waypoint even if you don't know its position or location on the map. This unit lets you project the location of a waypoint from a known waypoint using only bearing and distance from the known waypoint. This is useful if you don't know the latitude/longitude of a location, but you do know the distance and bearing from a saved waypoint or your own position.

(Note: To project a waypoint from your present position, you must first save your present position as a waypoint.)

To use this feature, press the WPT key, then select a waypoint number that you want to save the projected waypoint under. Waypoint 7 is used in this example. Now select "CREATE WAYPOINT", then "PROJECT POSITION". The screen shown at the top of this page appears.

The unit needs a location (reference waypoint) to project the new waypoint from. The default reference is waypoint number one. Highlight the "REFERENCE WPT" label on the Project WPT menu and press the right arrow key. The screen below right appears. Select a waypoint using either the waypoint number or waypoint list. In this example, waypoint 4 was chosen. When you've chosen the waypoint, highlight the "SET REFERENCE" label and press the right arrow key. The unit returns to the Project WPT screen shown above. The starting waypoint you chose shows in the middle of this screen. Now set the distance from the starting waypoint to the projected waypoint by highlighting the "SET DISTANCE" label and pressing the right arrow key. Use the arrow keys to set the distance, then press the ENT key when you're finished. The unit returns to the Project Position screen. Now enter the bearing from the starting waypoint to the projected waypoint by selecting "SET BEARING" from the Project Position screen.

Once you've entered the bearing, the unit returns to the Project Position screen with the distance

PROJECT POSITION	
REFERENCE WAYPOINT	▶
SET DISTANCE	
SET BEARING	
REFERENCE	
WAYPOINT #1	
WPT 001*	N 36°11.770' W 96°18.804'
DESTINATION	
DISTANCE-0.00 MI	
BEARING-0° MAG	
ENTER TO PROJECT	
EXIT TO CANCEL	

WAYPOINT #	:	4
SET REFERENCE		▶
NAME SEARCH	:	WPT 004*
WAYPOINT LIST		
CREATE WAYPOINT		
EDIT WAYPOINT		
DELETE WAYPOINT		
MOVE WAYPOINT		
N 36°11.792'		DIS-1.20 MI
W 96°22.324'		BRG-42° MAG
11-JUN-98		SELECT A
4:31 P		WAYPOINT

PROJECT POSITION	
REFERENCE WAYPOINT	
SET DISTANCE	
SET BEARING	▶
REFERENCE	
WAYPOINT #4	
WPT 004*	N 36°11.792' W 96°22.324'
DESTINATION	
DISTANCE-2.50 MI	
BEARING-80° MAG	
ENTER TO PROJECT	
EXIT TO CANCEL	

WAYPOINT #	:	7
GO TO WAYPOINT		
NAME SEARCH	:	WPT 007*
WAYPOINT LIST		
CR	WAYPOINT	▶
E	CREATED	
DELETE WAYPOINT		
MOVE WAYPOINT		
N 36°11.969'		DIS-3.53 MI
W 96°19.641'		BRG-68° MAG
13-JUN-98		PRESS WPT TO
11:00 A		QUICK SAVE

and bearing from your present position showing at the bottom of the screen, as shown at right. In this example, the new waypoint is 3.53 miles on a bearing of 68° from our position. Now press the ENT key. The unit saves the projected location under the waypoint number that you picked at the beginning.

SELECTING A WAYPOINT

In order to edit or navigate to a waypoint, you must first select it. There are three ways to do this: by waypoint number, waypoint list, or search by name. All selection methods are on the main waypoint menu shown at right.



To select a waypoint by its number, simply highlight the "WAYPOINT #" label at the top of the waypoint menu, then press the left or right arrow keys until the desired waypoint number appears.

Select from List

The waypoint number selection method forces you to scroll through all waypoint numbers, whether there's a location saved in them or not. The waypoint list is composed only of saved waypoints. To use the list, select "WAYPOINT LIST" from the waypoint menu. The screen shown at right appears. The names of all waypoints stored in memory show on this list. Simply highlight the desired waypoint and press the right arrow key to select it. The waypoint menu reappears.

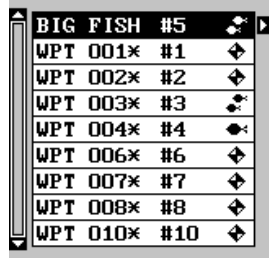

(Note: When created, a waypoint is given a default name designated by an asterisk (*). Default names are not shown on the map. The waypoint number is shown until it's renamed.)

Select by Name

To find a waypoint by its name, select "NAME SEARCH" from the waypoint menu. The screen at right appears. Using the arrow keys, type the waypoint's name on the screen. When the desired waypoint name appears, press the ENT key. The unit returns to the waypoint screen with the selected waypoint showing.

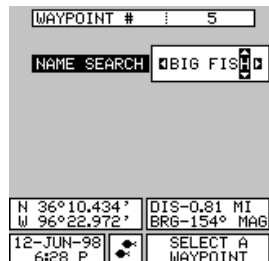

EDIT A WAYPOINT

You can customize a waypoint by giving it a name or change it's position or icon. To do this, first press the WPT key. The waypoint screen appears. Follow the instructions below for each item.

Position

Any latitude/longitude can be assigned to any waypoint by manually entering it using the keyboard. First select the waypoint number that you want to save a position under from the waypoint menu. Next, select "EDIT WAYPOINT", then select "EDIT POSITION". The screen shown at right appears. Using the left and right arrow keys, highlight each number in the position and change it using the up and down arrow keys. When you're ready to save this position and return to the waypoint screen, press the ENT key. Note: You can only use this method to change the position of an existing waypoint.

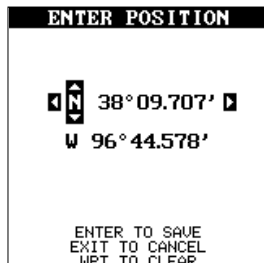

Name

You can assign a name to each waypoint. The name can have up to eight characters. To do this, first select the waypoint that you wish to name, then choose "EDIT NAME" from the Edit Waypoint menu. A screen similar to the one at right appears.



Press the up or down arrow keys to select the first letter in the name. Press the right arrow key to highlight the next position in the name. Repeat this sequence until you've entered all of the letters in the waypoint name. Press the ENT key to accept this name, the WPT key to erase all characters in the name, or the EXIT key to leave this screen without saving any changes.

Icon (Symbol)

To change the icon assigned to a waypoint, first select the waypoint, then choose "EDIT SYMBOL" from the Edit Waypoint menu. The icon selection screen appears. Use the arrow keys to select the icon that you want to assign to the waypoint, then press the ENT key. The waypoint now has the new icon.

Delete a Waypoint

To erase all of the information in a waypoint, first press the WPT key, then select the waypoint you want to erase. Now highlight the "DELETE WAY-

POINT” label and press the right arrow key. A message appears, asking if you really want to delete this waypoint. Press the right arrow key to delete it, the left to exit without deleting the waypoint.

Delete All Waypoints

You can remove all of the waypoints from the unit’s memory. To do this, press the MENU key, then highlight the “SYSTEM SETUP” menu and press the right arrow key. Now highlight the “DELETE ALL WPTS” label and press the right arrow key. The unit removes all waypoints from memory. Note: This also removes all routes from memory.

Move a Waypoint

You can move all information from one waypoint number to another to help organize the waypoints. In this example, we’ll move all of the information in waypoint number 1 to waypoint number 9. To do this, highlight the “MOVE WAYPOINT” on the waypoint screen and press the right arrow key. The screen shown at right appears. The “From” label is highlighted at the top of the screen. Press the right arrow key until the waypoint number that you want to move appears. In this example, we selected waypoint number 1. Now press the down arrow key once to highlight the “To” label. Press the left or right arrow key until the number that you want to move the waypoint to appears. Again, in this example, we chose to move waypoint number 1 to waypoint number 9, so we pressed the right arrow key until “9” appeared. As you can see on the screen above, waypoint number 1 is showing in the “From” box. Now press the ENT key. The “From” box is now empty and the “To” box has waypoint number 9. Press the EXIT key to erase this menu.

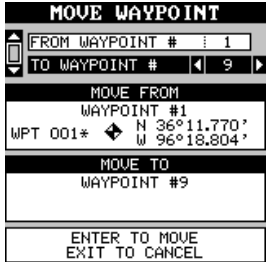

Waypoint Options

You can customize the method used to show a waypoint on the map screens. To do this, first press the MENU key, then select “MAP SETUP”, finally select “WAYPOINT OPTIONS”. The screen shown at right appears. You can turn all of the waypoints, their symbols, names, or numbers on or off. Simply select the desired label, then press the appropriate arrow key. Press the EXIT key to erase this menu.

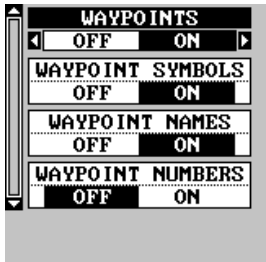

WAYPOINT NAVIGATION

This unit makes it easy to navigate to any waypoint. All you have to do is select the waypoint, then highlight the "GO TO WAYPOINT" label on the waypoint screen and press the right arrow key. The unit immediately shows navigation information to the waypoint on all navigation, map, and windows screens.



In this example, the waypoint named "BIG FISH" (#5) was recalled. Switching to the MAP-1 screen (shown at right) shows the starting location "S", the recalled waypoint "4", the plot trail from the starting location to the present position, and the present position arrow also shows the direction of travel (track).

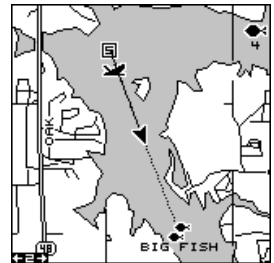

Navigating to a Cursor Position

This unit lets you navigate to a location without storing it in the waypoint database by using the map and cursor. To do this, first switch to a map. Now move the cursor to the location that you want to navigate to. Next, press the MENU key. A new, highlighted menu appears on the list: "Go To Cursor". Press the right arrow key. It now shows navigation data to the cursor location (shown as "D" on the map).

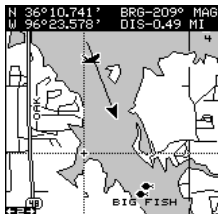

MOVE CURSOR TO DESIRED LOCATION



PRESS MENU KEY, THEN SELECT "GOTO CURSOR"

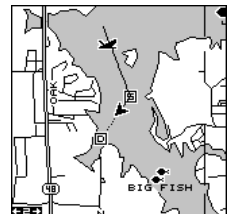

NAVIGATING TO CURSOR POSITION

Navigating to a Waypoint using the Map

The unique “birds-eye” view used by the map gives you an easy way to navigate to a waypoint. On the map screen shown at right, the arrow is your present position. The box with the “S” in it was your starting location when the waypoint was recalled. The dotted line is called a course line and is the shortest path from the starting location to the destination. The “D” is the cursor destination, when the cursor position is used as a destination. If you follow the course line, you’ll reach the destination, covering the shortest distance in the least time.

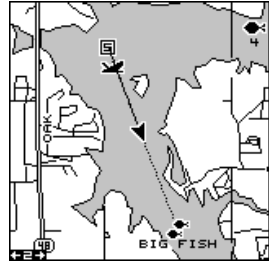

CAUTION!

This product does NOT take land features or any other feature into account when it projects the course line on the screen. Use caution when navigating to a location. Make certain there are no obstructions in your path.

CANCEL NAVIGATION

This unit continues to navigate to a recalled waypoint, the last waypoint in a route, or the cursor position until you stop it.

To stop the navigation function, press the MENU key, then press the up or down arrow keys until the “Cancel Nav” label is highlighted. Press the right arrow key. The unit stops showing navigation information.

ROUTES

You can connect several user waypoints together to form a route. When you recall the route, the unit shows navigation information to the first waypoint in the route, then when you reach that waypoint, it switches to the next waypoint, and so on until you reach the last waypoint in the route.

To create a route, first press the MENU key, highlight the “ROUTE PLAN-NING” label, and press the right arrow key. The screen shown at right appears.

This unit can store up to 99 routes. Route number one shows on this page. If you wish to create a route using a different number, simply press the left or right arrow keys until the desired route number appears. In this example, however, we’ll use route number one.



If you wish to name the route, highlight the “EDIT ROUTE NAME” label and press the right arrow key. Use the arrow keys to name the route, (you can use up to eight characters in the name) then press the ENT key when you’re finished.

The gray boxes in the lower portion of the screen comprise the list of waypoints that form the route. To add waypoints to the route, highlight the first gray box and press the right arrow key. The screen shown at right appears. To add a waypoint to the route from the waypoint table, select the “ADD WPT” label. To select a waypoint from the map, choose “ADD FROM MAP”.



Add From Waypoint List

This screen is virtually identical to the waypoint screen. Select a waypoint either by using the waypoint number, waypoint name, or from the waypoint list. After selecting the waypoint, highlight the “ADD TO ROUTE” label and press the right arrow key. The unit returns to the route screen with the first waypoint at the top of the list. Highlight the next waypoint location beneath the first waypoint and press the right arrow key. Now repeat the previous steps to select the second waypoint for your route. After selecting the second waypoint, the unit returns to the waypoint list screen. The second waypoint shows beneath the first one, with bearing and distance from the first waypoint in the route to the second showing under the second waypoint's name.

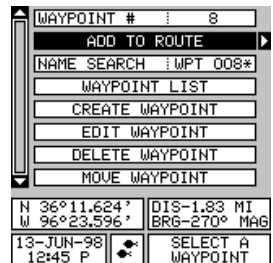

Add From Map

You can add waypoints from the map, even create new ones. To do this, select “ADD FROM MAP” from the menu as shown on the previous page. A screen similar to the one at right appears. Using the arrow keys, move the cursor to the desired waypoint or location. Now press the ENT key to add it to the route. If it’s an existing waypoint, it will be added to the route. If you mark a location with the cursor that isn’t a waypoint, the unit will

create a waypoint and add it to the route. To add another location or waypoint to the route, move the cursor to that location and press the ENT key. When you're finished, press the EXIT key. The screen below right appears.

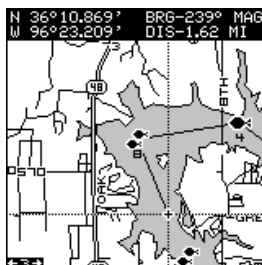

The total route distance shows at the bottom of the screen. Continue selecting waypoints until all of the waypoints in the route are on the list. Press the EXIT key to return to the Route menu. Your route is now saved in memory. Press the EXIT key to erase the menus.



Delete a Waypoint from the Route

To remove a waypoint from a route, first select the route, then select the waypoint that you want to delete and press the right arrow key. Highlight the "Delete" label on this menu and press the right arrow key. The unit returns to the route list with the waypoint removed from the list. (Note: This doesn't delete the waypoint from the database, it simply removes it from the route.)

Waypoint Statistics

By default, this unit shows the distance and bearing from each waypoint in the route to the next. It will also show estimated time en route (ETE), estimated time of arrival (ETA), or the waypoint names (NAMES). To view the different statistics, highlight the "SHOW INFO-DIS/BRG" label, then press the left or right arrow key until the desired statistic appears.

Follow a Route - Direct To Method

Before starting the route, you'll need to decide if you want to start at the first waypoint and travel forward to the last waypoint or start at the last waypoint in the route and travel backwards (reverse) to the first waypoint. The default is forward. You can also start at the closest waypoint to your position, then travel forward or reverse through the route using the "AUTO START" feature.

To follow a route, first select the route number that you wish to follow by highlighting the "Route #" label, and pressing the left or right arrow keys

until the desired route number appears. In this example we're using route number one. To run the route from the last waypoint to the first, highlight the "RUN ROUTE" label and press the right arrow key to change it from forward to reverse.

Now highlight the first waypoint in the route that you wish to start with and press the right arrow key. (The first waypoint in the route is used in this example.) The screen shown above right appears. Now select "DIRECT TO" and press the right arrow key.



The unit returns to the last used navigation, mapping, or windows screen. In this example, map screen 1 was in use. A box with the "S" inside represents your location when you started the route. A dotted line shows from your starting position to the waypoint. A dashed line extends from this waypoint to each of the other waypoints in the route. Follow these lines to get to each of the waypoints. When you enter the radius set by the arrival alarm, the unit automatically switches to the next waypoint on the list, showing navigation data to that waypoint, and so on until the last waypoint on the route list has been reached. (Note: The arrival alarm does not have to be turned on.) The unit continues to show navigation data to the last waypoint in the route until you end the navigation. (See Cancel Navigation)

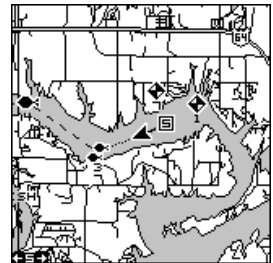

Following a Route - Auto Start Method

You don't have to choose the starting waypoint in a route. Selecting "AUTO START" on the route planning menu, starts navigation along the *leg* of the route that is closest to your present position. The screen shown at the top of the next page shows the result of the auto start feature. When the route was started, the first leg of the route (from waypoint #3 to waypoint #4) was the closest to the present position. Therefore, the unit shows navigation information to waypoint number 4. The first leg of the route, from #3 to #4 is shown on the screen by a dotted line. Once you arrive at waypoint number 4, the unit switches to the next waypoint in the route, and so on. The rest of the route navigation is used normally.

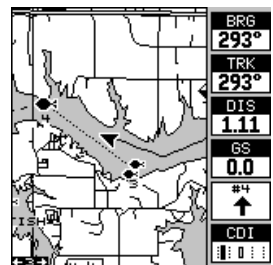

Waypoint Information

To see details about the highlighted waypoint, select the waypoint from the list of waypoints on the route screen, then press the right arrow key. Now select “WAYPOINT INFO”. The screen at right appears.

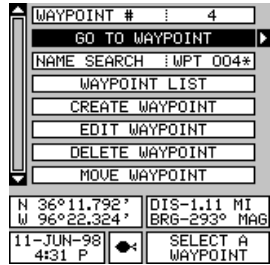

The selected waypoint number appears at the top of this screen. Information about the waypoint shows at the bottom of the screen. When you're finished with this screen, press the EXIT key to erase it.

Delete a Route

To erase a route, highlight the “ROUTE #” label on the route planning menu, then select the route you want to erase. Next, highlight the “DELETE ROUTE” label and press the right arrow key. A message appears, asking if you really want to erase the route. If you press the right arrow key, the route will be erased. If you select “Yes” (by pressing the right arrow key) the unit then asks if you want to erase the waypoints used in the route from memory also. Press the right arrow key again to erase them, or the left arrow key to leave the waypoints in memory. The unit returns to the routes menu. Press the EXIT key to erase the menu.

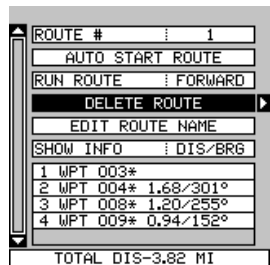

Note:

If you are navigating with this unit, either to a waypoint or in a route and shut it off, it will preserve the current waypoint number that it is navigating to. It also saves the current route (if it is in use) and the route's forward or reverse order. When you turn the unit on, it will show navigation data to the waypoint as soon as it locks onto the satellites as if it had never been turned off.

SYSTEM SETUP

Many features are listed under the “System Setup” label on the main menu. These commands affect the basic operation of the unit. To use them, press the MENU key, then “System Setup”. The screen at right appears.



Audio/Screen

This unit gives you three audio options. 1. The unit will sound a tone whenever an alarm sounds and when you press a key. 2. The unit sounds the alarm only. 3. No sound. To change the audio mode, highlight the “SOUND” label as shown below, then press the right or left arrow keys. Note: If the speaker is turned completely off the alarm messages will still flash on the screen.

Contrast

To adjust the display’s contrast, highlight the “Contrast” label. Press the right or left arrow keys until the screen’s contrast is best for the lighting conditions.



Backlight

The display has lights that can be turned on for night use. To turn the lights on, simply press the PWR key. To turn them off, press the PWR key again. A light bulb indicator on the satellite status screen shows when the lights are on.

The default light level is maximum. To reduce the level, select “BACKLIGHT LEVEL”, then press the left arrow key until the lights are at the desired level. To increase the light level, press the right arrow key.

Set Local Time

When this unit is first initialized, it may not show the correct time for your location due to daylight savings time, time zone variances, and so on. If the time shown on the clock displays is incorrect, select “SET LOCAL TIME” from the system setup menu and press the right arrow key. The screen shown at right appears.



Use the left or right arrow keys to select the number in the current time that you want to change. Use the up or down arrow keys to change the number. Press the ENT key to save the change, the EXIT key to erase the menu without changing it.

Change Units

You can view data in three different formats: statute, nautical, and metric. The default is statute. The chart below shows the settings for each.

Statute	Nautical	Metric
Distance miles	nautical miles	kilometers
Speed miles per hour	knots	kilometers per hour
Altitude feet	feet	meters

The unit will also show bearing in degrees true or magnetic, and the clock in 12 hour (a.m./p.m.) or 24 hour formats. The UltraMap can also show water depth in feet, fathoms, or meters, temperature in degrees Fahrenheit or Celsius, (temperature requires an optional temp sensor) .To change a unit of measure, first select "Change Units" from the System Setup menu. Highlight the desired selection, then press the left or right arrow key. You can change any or all of the settings on this page. When you're finished, press the EXIT key.

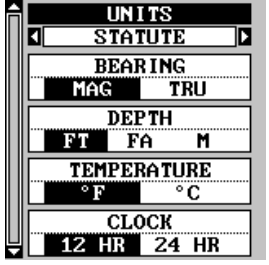

NMEA/DGPS

This product transmits data through the power/data port in the back of the unit using NMEA 0183 format, version 1.5 or 2.0. The data is used by other electronic devices such as marine autopilots for position and steering information.

DGPS on the other hand, is a data input. DGPS is an acronym for Differential Global Positioning System. Currently, it relies on a system of ground-based transmitters that send correction signals to small DGPS receivers. DGPS gives you more accurate positions than is otherwise possible.

See the installation section for cable connections. See the sample wiring diagram below for general wiring procedures. Read your other product's owner's manual for more wiring information.

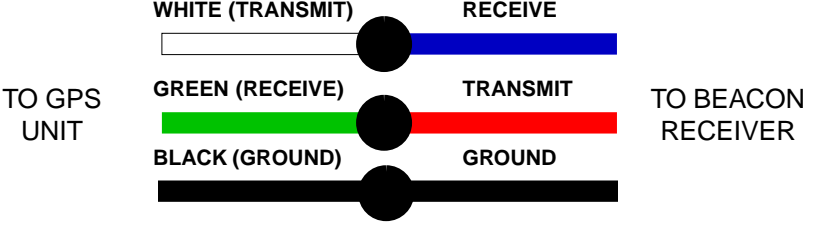

Once the cables are wired, turn the unit on, press the menu key, and select “NMEA / DGPS CONFIG” from the System Setup menu. A screen similar to the one at right appears.



To turn the NMEA output on, highlight the “NMEA OUT” menu (shown at right), then press the right arrow key. If your other equipment works, then no setup will need to be performed. If your other equipment doesn’t recognize the NMEA data being sent by this unit and the wiring is correct, then you may need to change the NMEA or the serial communication settings.

Configure NMEA

Highlight the “Configure NMEA” menu, then press the right arrow key. The screen shown at right appears.

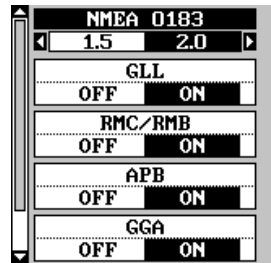

NMEA 0183 Version

There are two versions of the NMEA data, 1.5 and 2.0. If your other equipment requires 1.5, press the left arrow key to select it.

GLL, RMC/RMB, APB, GGA, GSA/GSV Sentences

Some equipment requires different sentence. The default setting for these sentences is on. In other words, it automatically sends these sentences when NMEA is turned on. To turn any of these off, move the black box to the desired menu and press the left arrow key. Press the EXIT key when everything on this screen is the way you want it.

DGPS

This unit will recognize Starlink® and Magnavox® automatic DGPS receivers. If you have either one of these receivers, simply highlight the “STARLINK DGPS” or “MAGNAVOX DGPS” on the NMEA / DGPS menu (shown at the top of this page) and press the right arrow key to turn it on. (Note: If you have a Magnavox DGPS receiver connected, this unit can’t send NMEA data.) With the exception of serial communications, typically no other setup needs to be made with these receivers.

If you have any other Magnavox or Starlink compatible DGPS receiver connected to this unit, you may need to change the settings. To do this, move the black box to the “Configure DGPS” label and press the right arrow key. A screen similar to the one at the top of the next page appears.

These menus select the beacon receiver's frequency and bit rate (in bits per second). To change one of these settings, simply highlight the menu item you wish to change, then press the right or left arrow key until the desired number appears.

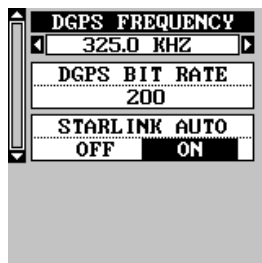

The "STARLINK AUTO" menu works with the Starlink or compatible receivers that automatically determine the frequency and bit rate. If you have one of these receivers, leave this set to "ON", otherwise turn it off.

Press the EXIT key when you're finished.

Com Port Setup

If you're connecting a computer or other serial device to this unit, (including DGPS receivers) you'll probably need to change the communications settings. To do this, select "Com Port Setup" on the System Setup menu. Press the right arrow key. The screen shown at right appears.

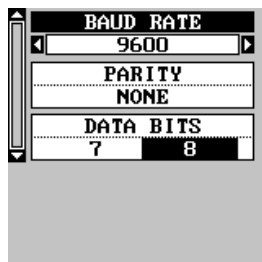

Check your computer or DGPS receiver's manual for the proper data settings. Highlight the menu item you need to change. Press the left or right arrow keys to change them. The serial port defaults are 4800 baud, no parity, and 8 data bits. Press the EXIT key to erase this menu.

Reset Groups

To return all window groups and boxes on the navigation and mapping screens to their factory defaults, select Reset Groups on the System Setup menu. Finally, press the right arrow key. All window groups and digital boxes are reset to their factory settings.

Reset Options

To return the unit to the original factory settings, highlight the "Reset Options" menu on the System Setup screen. Now press the right arrow key. A message appears, asking if you want to restore the original options. Press the right arrow key if you do, the left arrow key to quit.

If you restore the unit to the factory settings, all options such as contrast, alarms, and other system choices are returned to their default values. However, no waypoints, routes, or icons are erased.

System Information

The system information screen shows the release date and the software's version number. To view this screen, highlight the System Info label on the System Setup menu. Now press the right arrow key. Press the EXIT key when you're finished reading this screen.

GPS SETUP

Items found under the GPS Setup menu include initialization, (covered at the beginning of this manual), position format, datums, and more. To use any of these features, first press the MENU key, highlight GPS Setup and press the right arrow key. The screen shown at right appears.



Position Format/Alternate Format

This unit can show the position in degrees, minutes, and thousandths of a minute ($36^{\circ} 28.700'$) or degrees, minutes, seconds, and tenths of a second ($36^{\circ} 28' 40.9''$). It can also show position in UTM (Universal Transverse Mercator) projection, German, Taiwan, British, Irish, Swedish, Swiss, Finnish, New Zealand, and Military Grid.

UTM's are marked on USGS topographic charts. This system divides the Earth into 60 zones, each 6 degrees wide in longitude.

German, Taiwan, British, Irish, Swedish, Swiss, New Zealand, and Finnish grid systems are the national coordinate system used only in their respective countries. In order to use these grid systems, you must be in the respective country. This unit will pick the matching datum for you when you select the grid. See the Datums section for more information.

The military grid reference system (MGRS) uses two grid lettering schemes, which are referred to as standard and alternate MGRS on this unit. Your position and datum in use determines which one to use. If you use standard, and your position is off significantly, then try the alternate.

Note: When the position format is changed, it affects the way all positions are shown on all screens. This includes waypoints.

Windows Group "F" has two position displays, standard (shown at the top of the screen), which is also shown on all other position displays, and alternate. The alternate position (shown at the bottom of the screen) can be programmed to show your present position in a different format than the upper position. For example, you can show latitude/longitude at the top of the screen and UTM's at the bottom.

To change the position format, highlight either the "Position Format" or the "Alternate Format" label on the "GPS Setup" menu, then press the right arrow key. A screen similar to the one at right appears. Press the up or down arrow keys to select the desired format. Press the EXIT key to erase the position format menu.



Datum

Maps and charts are based on a survey of the area that's covered by the map or chart. These surveys are called "Datums". Maps that are created using different datums will show the same latitude/longitude in slightly different locations.

All datums are named. The GPS system is based on the WGS-84 datum, which covers the entire world. Other datums may also cover the entire world, or just a small portion. By default, your position shows using the WGS-84 datum. However, it can show your position using one of 191 different datums.

To change the datum, first press the MENU key, then highlight the "GPS Setup" label and press the right arrow key. Now highlight the "Select Datum" label. Finally, press the right arrow key again. A screen similar to the one at right appears.

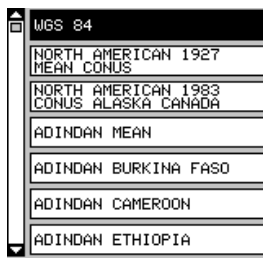

The WGS-84 label is highlighted. To change it, simply press the up or down arrow keys to highlight the desired datum, then press the ENT key. This selects the datum and erases the select datum menu.

A list of the datums used by this unit is in the back of this manual.

Set PCF Offset

Another method used to make your display match a chart or map is called "PCF" or Position Correction Factor. This unit gives you the capability to move or offset the position shown on the display to match one on the chart. The unit will add this offset to all position and navigation displays at all times.

Remember, the position error on any radio navigation system is very dynamic and the PCF offset should never be used in an attempt to cancel the error.

In general terms, PCF should only be used if your map indicates what the possible error is. PCF should always be reset to zero when you're finished with the chart.

For example, suppose you are stopped at a location that is accurately marked on a chart. Your unit shows a longitude position that is .244 minutes east of the one on the chart and .047 minutes north latitude. Using the PCF feature, you can make this unit match the chart you're using. If you move, the unit will continuously add the change to all position, navigation, and mapping displays. This makes it more closely match the datum used by the chart. For this reason, you should be careful when entering the PCF offset. It's saved in memory and doesn't change when the unit is turned off. However, resetting the unit does erase the PCF offset.

To change the PCF offset, first press the MENU key, then highlight the "GPS Setup" label and press the right arrow key. Now highlight the "Set PCF Offset" label. Finally, press the right arrow key again.



A screen similar to the one at right appears.

Now enter the correction for your location. Remember, this is the difference between the location shown on the present position display and the position shown on the chart. In this example, we entered 0 degrees, 0.047 minutes north latitude and 0 degrees, 0.244 minutes east longitude. That is the difference between the present position shown by this unit and the one on our chart.

After you've entered the latitude/longitude correction, press the ENT key to accept it. The PCF entry screen is erased and the unit returns to the navigation or mapping screens with the correction factor applied.

Position Pinning

When using a GPS receiver at extremely low speeds, it can have trouble determining your course over ground, or direction you're travelling. This is due in large part to SA, or selective availability. SA is small inaccuracies purposefully put into the GPS satellite's signal by the government. This cause wide variations in the track display and other navigation displays when using the unit at slow speeds.

If you're using this receiver without DGPS and stop, the position pinning feature locks the present position indicator on the plotter until you've moved a short distance or exceed a very slow speed. This prevents the "wandering" plot trail seen when you're stopped with position pinning turned off. This also affects the navigational displays.

The easiest way to see the effects of S/A is to stand still with the GPS

receiver turned on and watch your plot trail with position pinning turned off. You'll see the present position change, speed increase and decrease, and a random plot trail on the plotter's screen.

If you wish to turn the position pinning feature off, press the MENU key, then highlight the "GPS Setup" label and press the right arrow key. Now highlight the "POSITION PINNING" label. Finally, press the left arrow key.

ALARMS

This unit has several GPS alarms. (Sonar alarms for the UltraMap are covered in the sonar section of this manual.) You can set an arrival alarm to flash a warning message and sound a tone when you cross a preset distance from a waypoint. For example, if you have the arrival alarm set to .1 mile, then the alarm will flash a message when you come within .1 mile of the recalled waypoint. The course deviation indicator alarm (CDI) can warn when your track drifts too far to the right or left of the course line to the waypoint. For example, if the alarm is set to .1 mile, then the alarm flashes a message if you drift .1 of a mile or more to the right or left of the line to the waypoint. The anchor alarm is triggered when you drift outside of a preset radius. Again, using the .1 mile as an example, if you're anchored and your boat moves more than .1 of a mile, the alarm will flash a message and sound a tone.

To use any of these alarms, first press the MENU key, then select the "ALARMS" menu. Next, select "GPS ALARMS". A screen similar to the one shown at right appears. Press the up or down arrow key to select the desired alarm, then press the right arrow key to turn it on.

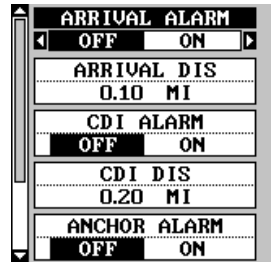

To adjust an alarm's distance, move the black box to the alarm's "DIS" menu item, then press the right or left arrow keys to increase or decrease the alarm's distance.

When you're finished, press the EXIT key to erase this menu.

Important Alarm Notes:

Anchor Alarm - Since civilian users don't receive the accuracy given to military users, the anchor alarm may be triggered even when you're sitting still. This typically happens when using small (less than .05 mile) anchor alarm ranges. If you have a DGPS beacon receiver connected to this unit, smaller ranges may be usable.

Arrival Alarm - If you set the arrival alarm's distance to a small number,

and you run a route (see the routes section), this unit may not show navigation data to the next waypoint, once you arrive at the first one, since you may not be able to come close enough to the first waypoint to trip the arrival alarm.

DGPS Messages

The DGPS message selections are found on the Alarms/CDI menu shown above. Pressing the EXIT key erases these messages.

The DGPS message appears whenever the unit begins or stops using DGPS data to help determine your position.

The default setting for these messages is “on”. To turn the message off, select the “Setup Alarms” menu from the main menu, then highlight “DGPS MESSAGES” and press the left arrow key.

Sun/Moon Calculator

This unit has a sunrise/sunset and moonrise/moonset calculator that shows this information anywhere or anytime in the world. To use it, press the MENU key, then highlight “SUN/MOON CALC” and press the right arrow key. The screen shown at right appears. (Both calculators work identically. The sunrise/sunset calculator is used for this example.) The sun and moon data for today’s date appear in the center of the screen.

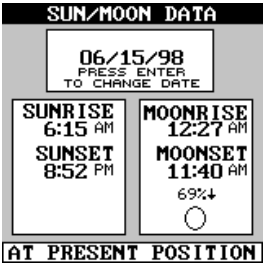

A moon symbol shows in the moonrise/moonset box, showing the approximate phase of the moon. The arrow next to the symbol shows if it is moving towards a full moon (up) or a new moon (down).

Today’s date shows at the top of the screen. If you want to know the sunrise/sunset for a different date, press the ENT key, then enter the new date with the arrow keys. The unit returns to the above screen with the sun and moon data shown for the date you entered.

The sun and moon data show for your present position. If you move the plotter’s cursor to a different position before using this calculator, it will show the sunrise/sunset for the cursor’s location.

Press the EXIT key to erase this screen.

SIMULATOR

A simulator is built into this unit that moves the GPS position and produces a simulated sonar chart (UltraMap only). You can use nearly all of the unit's features - even save and recall waypoints. This is useful for trip planning.

To use the simulator, press the MENU key, then press the up or down arrow keys until the "Simulator Setup" menu is surrounded by the black box. Now press the right arrow key. The screen shown at right appears.



If you simply press the right arrow key, turning the simulator on, this unit will start from your present position and follow a track of 355° at 100 miles per hour.

To change either the track or speed, highlight the one you want to change, then press the right or left arrow key. When the numbers are correct, press the EXIT key.

Starting Position

Normally, the starting position for the simulator is your present position. If you want to change the starting position, highlight the "SET START WPT" label on the Simulator Setup menu, then press the right arrow key.

You can select any waypoint as the simulator's starting point. Select the starting point by pressing the right arrow key on the "WPT#" label until the desired starting waypoint number appears. Now highlight the "SET SIM START" label and press the right arrow key. The unit returns to the Simulator Setup menu using the specified waypoint as the starting waypoint.

Steer Simulator

This option lets you change both the course and speed on the screen as the simulator is running. To do this, highlight the "STEER SIMULATOR" label on the Simulator Setup screen, then press the right arrow key. The screen shown at right appears. Use the up and down arrow keys to increase or decrease the speed. Use the right and left arrow keys to change the track. When you're finished changing the track and speed, press the EXIT key to erase the menus.



SONAR OPERATION - UltraMap Only

SONAR MODES

This unit has three different sonar modes: full chart (sonar 1), split-chart (sonar 2), and sonar with digital information (sonar 3). To select a mode, first press the PAGES key. Press the up or down arrow key to select sonar modes, then press the left or right arrow key to select the desired mode. Press the EXIT key to erase the modes menu.

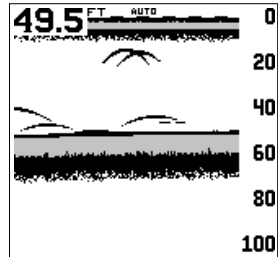

Full Chart

This is the default mode used when the unit is first turned on (shown above). The bottom signal scrolls across the screen from right to left. Depth scales on the right side of the screen makes it easy to determine the depth of fish, structure, and other objects. The line at the top of the screen represents the surface. The bottom depth shows at the top left corner of the screen. The word "AUTO" at the screen's top center shows that it's in the automatic mode, freeing you from sensitivity, range, and noise rejection adjustments.

Split Chart

A split chart shows the underwater world from the surface to the bottom on the right side of the screen. The left side shows an enlarged version of the right side. The zoom range shows at the bottom of the screen. In this example, the zoom range is 2X, or two times the right side's view.

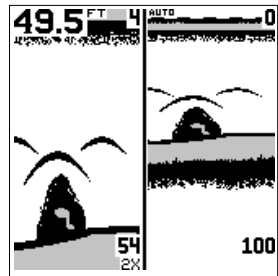

Digital/Chart

The digital/chart shows the chart on the left side of the screen. The right side has six digital boxes containing the water depth at the top of the screen, boat speed, surface water temperature, temperature #2, waypoint number with direction arrow, and CDI. (Note: Boat speed, distance, and temperature require an optional speed/temperature sensor. Temperature #2 requires an additional temperature sensor.)

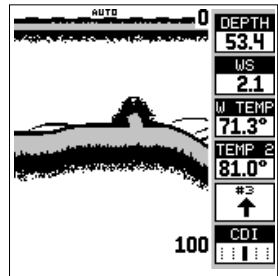

AUTOMATIC

When this unit is first turned on, the automatic feature is enabled. This is indicated by the word "AUTO" at the top of the screen. The automatic feature adjusts the sensitivity and range so the bottom signal is displayed in the lower half of the screen at all times.

To turn automatic off, first press the MENU key, then select "SONAR SETUP". Now select "SONAR AUTO MODE". Press the left arrow key to switch to the manual mode. Press the EXIT key to return to the sonar screen. To turn Automatic on, repeat the above steps to get the auto menu, then press the right arrow key.

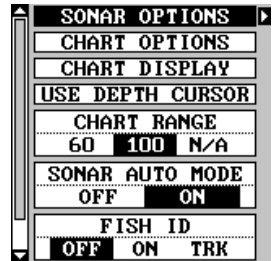

SONAR OPTIONS

Sensitivity

The sensitivity controls the ability of the unit to pick up echoes. A low sensitivity level excludes much of the bottom information, fish signals, and other target information. High sensitivity levels enables you to see this detail, but it can also clutter the screen with many undesired signals. Typically, the best sensitivity level shows a good solid bottom signal with Grayline and some surface clutter.

The sensitivity is adjusted to keep a solid bottom signal displayed, plus a little more when the unit is in the automatic mode. This gives it the capability to show fish and other detail.

However, situations occur where it becomes necessary to increase or decrease the sensitivity. This typically happens when you wish to see more detail, so an increase in sensitivity is indicated. The procedure to adjust it is the same whether the unit is in the automatic or manual mode.

To adjust the sensitivity, press the MENU key, then select "SONAR OPTIONS". The screen at right appears. There are four options on this menu, with two showing. They are: sensitivity, grayline, surface clarity, and ASP. Use the up or down arrow keys to switch between options. The sensitivity menu has left and right arrows, plus a horizontal bar graph. The graph gives a visual indication of the sensitivity level. The number to the right of the bar graph shows the percentage of sensitivity in use.

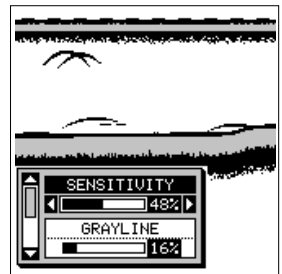

To increase the sensitivity level, press the right arrow key. As you press

the key, the menu's bar graph will grow wider and the percentage will increase in value. You can also see the difference on the chart record as it scrolls. When the sensitivity is at the desired level, release the key.

To decrease the sensitivity level, press the left arrow key. The bar graph and percentage will decrease. When the sensitivity is at the desired level, release the key. When you reach either the maximum or minimum limit, a tone sounds.

To erase the menu, press the EXIT key.

GRAYLINE®

GRAYLINE lets you distinguish between strong and weak echoes. It "paints" gray on targets that are stronger than a preset value. This allows you to tell the difference between a hard and soft bottom. For example, a soft, muddy or weedy bottom returns a weaker signal which is shown with a narrow or no gray line. A hard bottom returns a strong signal which causes a wide gray line.

If you have two signals of equal size, one with gray and the other without, then the target with gray is the stronger signal. This helps distinguish weeds from trees on the bottom, or fish from structure.

GRAYLINE is adjustable. Since GRAYLINE shows the difference between strong and weak signals, adjusting the sensitivity may require a different GRAYLINE level, also. The level chosen by the unit at power on is usually adequate for most conditions. Experiment with your unit to find the GRAYLINE setting that's best for you.

To adjust the GRAYLINE level, press the MENU key, then select "SONAR OPTIONS". The screen at the bottom of the previous page appears. Use the up or down arrow keys to select the GRAYLINE menu. Press the left arrow key to decrease the gray level or the right arrow key to increase it. The percentage of GRAYLINE in use changes as the arrow keys are pressed. The bar chart also gives a graphical indication of the GRAYLINE level. You can see the change on the screen (both on the menu and on the chart record) as you press the keys. After you've finished, press the EXIT key to erase the menu.

ADJUST CHART SURFACE CLARITY

The markings extending downward from the zero line on the chart are called "surface clutter." These markings are caused by wave action, boat wakes, temperature inversion, and other natural causes.

The Surface Clarity Control (SCC) reduces or eliminates surface clutter signals from the display. SCC varies the sensitivity of the receiver, decreasing it near the surface and gradually increasing it as the depth increases.

There are three levels of SCC available on this unit: low, medium, and high. When it's turned on for the first time, the SCC level is low. To change it, press the MENU key, then select "SONAR OPTIONS". The screen at right appears. Use the up or down arrow keys to select the SURFACE CLARITY menu. Now use the left or right arrow keys to change it. When you're finished, press the EXIT key to erase the menus.

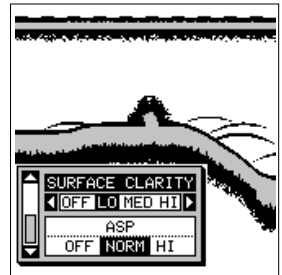

ASP (Advanced Signal Processing)

The ASP feature is a noise rejection system that constantly evaluates the effects of boat speed, water conditions, and interference. This automatic feature gives you the best display possible under most conditions.

The ASP feature is an effective tool in combating noise. In sonar terms, noise is any undesired signal. It is caused by electrical and mechanical sources such as bilge pumps, engine ignition systems and wiring, air bubbles passing over the face of the transducer, even vibration from the engine. In all cases, noise can produce unwanted marks on the display.

The ASP feature has two levels - Normal and High. If you have high noise levels, try using the "High" ASP setting. However, if you are having trouble with noise, we suggest that you take steps to find the interference source and fix it, rather than continually using the unit with the high ASP setting. However, there are times when you may want to turn the ASP feature off. This lets you view all incoming echoes before they are processed by the ASP feature.

To change the ASP level, press the MENU key, select "SONAR SETUP", then "SONAR OPTIONS", and finally press the up or down arrow keys until the "ASP" menu appears, as shown at the top of this page. Now use the left or right arrow keys to change it. When you're finished, press the EXIT key to erase the menu.

RANGE - Automatic

When turned on for the first time, the bottom signal is automatically placed in the lower half of the screen. This is called Auto Ranging and is part of the automatic function. Typically, the range cannot be changed manually

while the unit is in automatic, as shown at right. However, depending upon the bottom depth and the current range, you can change the range to a different depth. In the example screen shown at right, the bottom depth has descended to a point where you can change the range to XX feet. To do this, select "CHART RANGE" from the "SONAR OPTIONS" menu. Simply press the right or left arrow keys to select a different range. When you're finished, press the EXIT key to erase the menu.

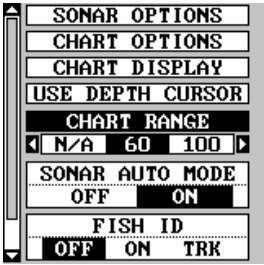

RANGE - Manual

You have complete control over the range when the unit is in the manual mode.

To change the range, first make certain the unit is in the manual mode. Next, select "CHART RANGE" from the "SONAR OPTIONS" menu. Simply press the right or left arrow keys to select a different range. Press the left or right arrow keys to decrease or increase the range. The available ranges are 0-10, 20, 30, 40, 60, 100, 150, 200, 300, 500, 800, and 1000 feet. After selecting the range, press the EXIT key to erase the range menu.

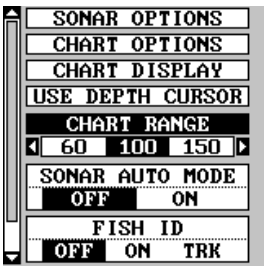

NOTE: The sonar's depth capability depends on the transducer installation, water and bottom conditions, and other factors.

CHART OPTIONS

Chart Speed

The rate echoes scroll across the screen is called the chart speed. It's adjustable by selecting "CHART SPEED" from the "CHART OPTIONS" menu. Increase the chart speed by pressing the right arrow key or decrease it by pressing the left arrow key. The percentage of chart speed in use changes as the arrow keys are pressed. The bar chart also gives a graphical indication of the chart speed. After you've made the adjustment, press the EXIT key to erase the menu.



Chart Stop

To stop the chart, select "CHART" from the chart options menu. Press the

left arrow key to stop the chart. To start the chart again, press the right arrow key.

ZOOM

“Zooming” the picture is a common method used to enlarge small detail and fish signals. To zoom the screen, simply press the ZIN (zoom-in) key. This enlarges all echoes on the screen to twice their normal size. To return the screen to 2X or normal, simply press the ZOUT (zoom-out) key until the desired zoom appears. When the unit is in zoom, “2X” appears in the lower right corner of the screen, showing the current zoom mode.

FISH ID

The Fish ID feature identifies targets that meet certain conditions as fish. The microcomputer analyses all echoes and eliminates surface clutter, thermoclines, and other signals that are undesirable. In most instances, remaining targets are fish. The Fish ID feature displays symbols on the screen in place of the actual fish echoes. There are four fish symbol sizes: tiny, small, medium, and large. These are used to designate the relative size between targets. In other words, it displays a small fish symbol when it thinks a target is a small fish, a medium fish symbol on a larger target, etc.

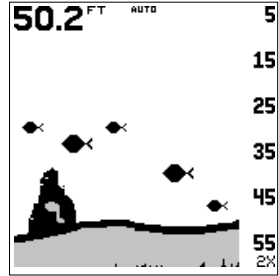

The microcomputer is sophisticated, but it can be fooled. It can't distinguish between fish and other suspended objects such as trotlines, turtles, submerged floats, air bubbles, etc. Individual tree limbs extending outwards from a group of limbs is the hardest object for the Fish ID feature to distinguish from fish.

You may see Fish ID symbols on the screen when actually, there are no fish. Practice with the unit in both the Fish ID mode and without to become more familiar with the Fish ID feature.

To turn the Fish ID feature off, press the MENU key, then select "SONAR SETUP". Now choose "FISH ID" from this menu. Press the left arrow key to turn the fish ID feature off. To turn the Fish ID feature on again, repeat the above steps, but press the right arrow key until the "ON" is highlighted. Any targets the microcomputer determines are fish will be displayed as fish symbols.

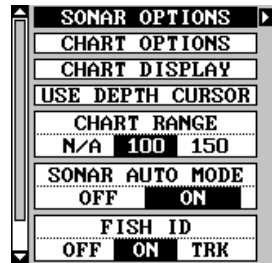

Remember, the Fish ID feature can't be used when the unit is in the manual mode. If you turn the Fish ID feature on when the unit is in the manual mode, the microcomputer will turn the automatic feature on. If you turn automatic off when the Fish ID feature is on, the Fish ID feature will be turned off also.

FISHTRACK™

The FishTrack feature shows the depth of a fish symbol when it appears on the display. This lets you accurately gauge the depth of targets. This feature is available only when the Fish ID feature is on.

To turn the FishTrack feature off, press the menu key and select "SONAR SETUP". Choose "FISH ID" from this menu. Now press the right arrow key to highlight the "TRK" FishTrack feature. To turn FishTrack off, press the left arrow key on the Fish ID menu.

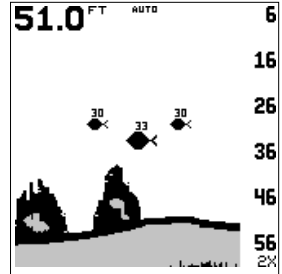
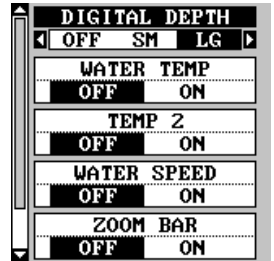

CHART DISPLAY

The chart display lets you set up the screen to show the digital displays, such as depth, temperature, and water speed. You can also turn the zoom bar and zone alarm bars on or off. To make these changes, press the MENU key and select "SONAR SETUP", then select "CHART DISPLAY". The screen shown at right appears.



The digital depth display at the top left corner of the screen normally shows in large numbers. You can change this to smaller numbers or turn it off completely by selecting "DIGITAL DEPTH" at the top of the screen.

Use the up or down arrow keys to select an item, then use the left or right arrow keys to change it. Press the EXIT key to erase this menu.

Zoom Bar

The zoom bar shows the section of water on the right side of SONAR-2 that is being enlarged on the left side. To turn the zoom bar on continuously, select "ZOOM BAR" on the "CHART DISPLAY" menu, then press the right arrow key. Now press the EXIT key. A screen similar to the one at right appears. Press the up arrow key to move the zoom bar up or the down arrow key to move it down. This moves the zoom coverage area. To turn the zoom bar off, repeat the above steps.

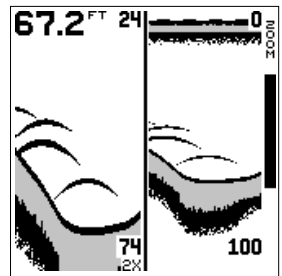

Zone Alarm Bar

The zone alarm has a range bar. Any echoes that appear between the top and bottom of this bar triggers the zone alarm. This bar normally doesn't show on the screen. To turn the zone bar on continuously, select "ZONE BAR" from the "CHART DISPLAY" menu, then press the right arrow key. Now press the EXIT key. A screen similar to the one at right appears. To turn the zone bar off, repeat the above steps.

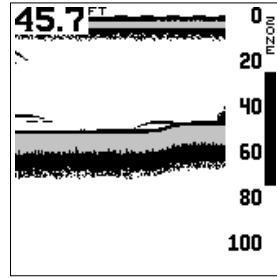

See the Alarms section for more information on the zone alarm.

CHART CURSOR

This unit has a chart cursor that allows you to pinpoint a target's depth. The cursor is simply a horizontal line that extends across the display from left to right. A depth box at the end of the line on the right side shows the line's depth. In the example at right, the cursor (line) is at 41.1 feet.

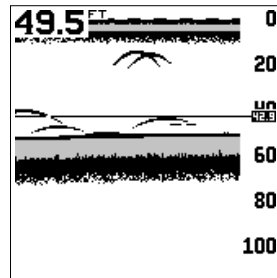

To display the chart cursor, press the MENU key and select "SONAR SETUP", then select "USE DEPTH CURSOR". A screen similar to the one at right appears. Use the up and down arrow keys to move the cursor up or down to the desired depth.

To turn the chart cursor off, simply press the EXIT key.

DIGITAL SONAR

Normally, the digital depth display is located at the top left corner of the screen. This display comes from a separate digital sonar built into the unit. It displays only the bottom depth. If it loses the bottom, the last known depth will flash on the display. When the digital finds the bottom, it will automatically display the bottom depth again. The digital sonar can be turned off, however this also turns all automatic features off also, such as auto sensitivity, auto ranging, and the Fish ID. feature.

To turn the digital off, first press the MENU key and select "SONAR SETUP", then select "DIGITAL SONAR". Press the left arrow to turn it off.

CAUTION!

Turning the digital sonar off also turns the automatic mode off, including Fish ID, and the depth alarms.

ALARMS

This unit has three different types of sonar alarms. The first is the Fish Alarm. It sounds when the Fish I.D. feature determines an echo or group of echoes is a fish. Another alarm is the Zone Alarm which consists of a bar. Any echo that appears inside this bar triggers this alarm. The last alarm is called the Depth Alarm. Only the bottom signal will trigger this alarm. This is useful as an anchor watch, a shallow water alert, or for navigation.

To adjust an alarm, first press the MENU key, then select "ALARMS". Now select "SONAR ALARMS". The screen shown at right appears. Follow the instructions below for setting each alarm.



DEPTH ALARMS

The depth alarms sound a tone when the bottom signal goes shallower than the shallow alarm's setting or deeper than the deep alarm's setting. For example, if you set the shallow alarm to ten feet, the alarm will sound a tone if the bottom signal is less than ten feet. It will continue to sound until the bottom goes deeper than 10 feet. The deep alarm works just the opposite. It sounds a warning tone if the bottom depth goes deeper than the alarm's setting. Both depth alarms work only off the digital bottom depth signals. No other targets will trip these alarms. If you turn the digital sonar off, the depth alarms will be inoperative. These alarms can be used at the same time or individually.

To adjust the shallow alarm, highlight the "Shallow Depth" label. To adjust the deep alarm, highlight the "Deep Depth" label. Both alarms adjust identically. We'll use the shallow alarm as an example. Highlight the "Shallow Depth" label, then press the right arrow key. The screen shown at right appears.



Use the up or down arrow keys to select the number, the right and left keys to move from number to number in the depth. For example, to set the shallow alarm depth to 10 feet, press the right arrow key once, then press the up arrow key once. This changes the second "0" to a "1". Next, press the right arrow key again and press the down arrow key once. This changes the "1" at the end of the number to a "0". The depth now shows 10 feet.

Press the ENT key to accept this setting. The unit returns to the alarms menu, showing a shallow depth of 10 feet. Now you can activate the alarm

by highlighting the “Shallow Alm” label and pressing the right arrow key.

With the shallow alarm set at ten feet, anytime the digital display goes below ten feet, the shallow alarm sounds.

Set the deep alarm in the same manner. If the bottom depth reading goes below the deep alarm setting, the deep alarm will sound.

ZONE ALARM

The zone alarm is triggered when any echo passes inside the zone alarm bar, shown on the right side of the screen. To turn the zone alarm on, highlight the “Zone Alarm” label on the sonar alarm menu, then press the right arrow key. To adjust the zone alarm, highlight the “Adjust Zone” label, then press the right arrow key. A screen similar to the one at right appears.

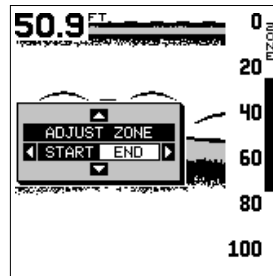

To adjust the top of the zone bar higher or lower, press the up or down arrow keys while the “START” label is highlighted as shown on the screen at right. To adjust the bottom of the zone bar, first press the right arrow key to select “END” on the screen, then use the up or down arrow keys.

When the zone alarm is set, press the EXIT key to erase the menus.

FISH ALARM

Use the fish alarm for a distinctive audible alarm when fish or other suspended objects are detected by the Fish I.D. feature. A different tone sounds for each fish symbol size shown on the display. To turn the fish alarm on, select “FISH ALARM” from the sonar alarm menu and press the right arrow key. The unit will revert to the sonar display with the fish alarm turned on. Repeat the above steps to turn the fish alarm off.

Note: If the unit is in the manual mode, turning the Fish Alarm on will also turn the automatic mode and Fish ID on, also.

Keel Offset

Normally, this unit measures water depth from the face of the transducer. Since the transducer is below the surface of the water, this distance is not the exact water depth. If the transducer is one foot below the surface, and the screen shows the water depth as 30 feet, then the depth is actually 31 feet.

You can calibrate the depth reading using the keel offset feature. First,

highlight the “SET KEEL OFFSET” label on the “System Setup” menu, then press the right arrow key. The screen shown at right appears. The current bottom depth shows in the upper left corner of the screen. The keel offset shows beneath it. In this example, we need to change the keel offset so that the unit will add one foot to the depth, since the transducer is one foot below the surface. Press the right arrow key, then the up or down arrow keys until +1.0 appears in the box, as shown at right, then press the ENT key. This immediately changes the digital depth display at the top of the screen by one foot. Press the EXIT key to erase this menu.



Note: Another way to use the keel offset feature is if you want to know the depth of the water below the lowest part of the boat, instead of the surface. To do this, measure the lowest part of the boat below the transducer. In this example, we’ll use 3 feet. Now, using the keel offset feature, adjust the offset for a *negative* 3 feet.

Please note that adjusting the keel offset only affects the digital depth display and all features that use the digital depth, such as the depth alarms and FishTrack. This doesn’t affect the chart at all.

Calibrate Speed

You can calibrate the speed display if an optional speed sensor is attached. To do this, highlight the “Calibrate Speed” label on the “System Setup” menu, then press the right arrow key. A screen similar to the one at right appears.



If the digital speed display is slower than your actual speed, add a positive percentage to make it read faster. If the digital speed display is faster, use a negative percentage to make it read slower. Use the arrow keys to change the speed, then press the ENT key. Press the EXIT key to erase this menu.

SONAR TROUBLESHOOTING

If your unit is not working, or if you need technical help, please use the following troubleshooting section before contacting the factory customer service department. It may save you the trouble of returning your unit.

Unit won't turn on:

1. Check the power cable's connection at the unit. Also check the wiring.
2. Make certain the power cable is wired properly. The red wire connects to the positive battery terminal, black to negative or ground.
3. Check the fuse.
4. Measure the battery voltage at the unit's power connector. It should be at least 11 volts. If it isn't, the wiring to the unit is defective, the battery terminals or wiring on the terminals are corroded, or the battery needs charging.

Unit freezes, locks up, or operates erratically:

1. Electrical noise from the boat's motor, trolling motor, or an accessory may be interfering with the sonar unit. Rerouting the power and transducer cables away from other electrical wiring on the boat may help. Route the sonar unit's power cable directly to the battery instead of through a fuse block or ignition switch
2. Inspect the transducer cable for breaks, cuts, or pinched wires.
3. Check both the transducer and power connectors. Make certain both are securely plugged in to the unit.

Weak bottom echo, digital readings erratic, or no fish signals:

1. Make certain transducer is pointing straight down. Clean the face of the transducer. Oil, dirt, and fuel can cause a film to form on the transducer, reducing its effectiveness. If the transducer is mounted inside the hull, be sure it is shooting through only one layer of fiberglass and that it is securely bonded to the hull. Do NOT use RTV silicone rubber adhesive or Marinetex
2. Electrical noise from the boat's motor can interfere with the sonar. This causes the sonar to automatically increase its Discrimination or noise rejection feature. This can cause the unit to eliminate weaker signals such as fish or even structure from the display.

3. The water may be deeper than the sonar's ability to find the bottom. If the sonar can't find the bottom signal while it's in the automatic mode, the digital will flash continuously. It may change the range to limits far greater than the water you are in. If this happens, place the unit in the manual mode, then change the range to a realistic one, (for example, 0-100 feet) and increase the sensitivity. As you move into shallower water, a bottom signal should appear.
4. Check the battery voltage. If the voltage drops, the unit's transmitter power also drops, reducing its ability to find the bottom or targets.

Bottom echo disappears at high speeds or erratic digital reading or weak bottom echo while boat is moving

1. The transducer may be in turbulent water. It must be mounted in a smooth flow of water in order for the sonar to work at all boat speeds. Air bubbles in the water disrupt the sonar signals, interfering with its ability to find the bottom or other targets. The technical term for this is Cavitation.
2. Electrical noise from the boat's motor can interfere with the sonar. This causes the sonar to automatically increase its Discrimination or noise rejection feature. This can cause the unit to eliminate weaker signals such as fish or even structure from the display. Try using resistor spark plugs or routing the sonar unit's power and transducer cables away from other electrical wiring on the boat.

No fish arches when the Fish ID feature is off:

1. Make certain transducer is pointing straight down. This is the most common problem if a partial arch is displayed.
2. The sensitivity may not be high enough. In order for the unit to display a fish arch, it has to be able to receive the fish's echo from the time it enters the cone until it leaves. If the sensitivity is not high enough, the unit shows the fish only when it is in the center of the cone.
3. Use the Zoom feature. It is much easier to display fish arches when zoomed in on a small range of water than a large one. For example, you will have much better luck seeing fish arches with a 30 to 60 foot range than a 0 to 60 foot range. This enlarges the targets, allowing the display to show much more detail.
4. The boat must be moving at a slow trolling speed to see fish arches. If the boat is motionless, fish stay in the cone, showing on the screen as straight horizontal lines.

NOISE

A major cause of sonar problems is electrical noise. This usually appears on the sonar's display as random patterns of dots or lines. In severe cases, it can completely cover the screen with black dots, or cause the unit operate erratically, or not at all.

To eliminate or minimize the effects of electrical noise, first try to determine the cause. With the boat at rest in the water, the first thing you should do is turn all electrical equipment on the boat off. Make certain the engine is off, also. Turn the sonar unit on, then turn off ASP (Advanced Signal Processing). There should be a steady bottom signal on the display. Now turn on each piece of electrical equipment on the boat and view the effect on the sonar's display. For example, turn on the bilge pump and view the sonar display for noise. If no noise is present, turn the pump off, then turn on the VHF radio and transmit. Keep doing this until all electrical equipment has been turned on, their effect on the sonar display noted, then turned off.

If you find noise interference from an electrical instrument, trolling motor, pump, or radio, try to isolate the problem. You can usually reroute the sonar unit's power cable and transducer cable away from the wiring that is causing the interference. VHF radio antenna cables radiate noise when transmitting, so be certain to keep the sonar's wires away from it. You may need to route the sonar unit's power cable directly to the battery to isolate it from other wiring on the boat.

If no noise displays on the sonar unit from electrical equipment, then make certain everything except the sonar unit is turned off, then start the engine. Increase the RPM with the gearshift in neutral. If noise appears on the display, the problem could be one of three things; spark plugs, alternator, or tachometer wiring. Try using resistor spark plugs, alternator filters, or routing the sonar unit's power cable away from engine wiring. Again, routing the power cable directly to the battery helps eliminate noise problems. Make certain to use the in-line fuse supplied with the unit when wiring the power cable to the battery.

When no noise appears on the sonar unit after all of the above tests, then the noise source is probably cavitation. Many novices or persons with limited experience make hasty sonar installations which function perfectly in shallow water, or when the boat is at rest. In nearly all cases, the cause of the malfunction will be the location and/or angle of the transducer. The face of the transducer must be placed in a location that has a smooth flow of water at all boat speeds. Read the transducer instructions for the best mounting position.

UPS Return Service

Eagle Electronics and United Parcel Service (UPS) are proud to offer all of our customers free shipping for all units sent to us for repair or service. If you have to send this unit to the factory, and you are in the continental United States, use the enclosed UPS shipping label for easy, free shipping to our factory customer service department. There are six easy steps:

1. Call Eagle at the toll-free number on the front of this flyer for a Return Authorization (RA) number and instructions about what accessories to return. **Do not return a product to the factory without a Return Authorization (RA) Number!**
2. Pack your unit and any accessories in the original shipping container, if possible. **Be sure to include proof of purchase for warranty verification!**
3. Write a brief note detailing the problem you're having with the unit. Please include your name, address, and daytime telephone number.
4. Please include payment for non-warranty repairs. Check, money order, Visa, or MasterCard may be used.
5. Fill in your name, address, zip code, date, and RA number in the blanks provided on the UPS form included with your unit.
6. Attach the label to the shipping box, tear off the tab for your receipt and give the package to any UPS driver or take the package to any UPS Customer Center. You will not be charged for this shipment.

That's it! Your unit will be shipped to Eagle's customer service department at no charge to you. Units under warranty will be returned to you at no charge.

NOTE!

Eagle will pay UPS surface shipping charges both to and from the factory for this unit in the event it needs repair. Your unit is insured against loss or shipping damage when you use the enclosed UPS label.

KEEP THIS LABEL!

**YOU WILL NEED IT IF YOU EVER NEED TO RETURN YOUR UNIT TO THE
FACTORY FOR REPAIR.**

Accessory Ordering Information

To order accessories such as power cables or transducers, please contact:

- 1) Your local marine dealer. Most quality dealers that handle marine electronic equipment should be able to assist you with these items. Consult your local telephone directory for listings.

- 2) LEI Extras, Inc. P.O. Box 129 Catoosa, OK 74015-0129
or call
800-324-0045
(USA orders only.)

EAGLE ELECTRONICS FULL ONE-YEAR WARRANTY

"We", "our", or "us" refers to EAGLE ELECTRONICS, a division of LEI, the manufacturer of this product. "You" or "your" refers to the first person who purchases this product as a consumer item for personal, family, or household use.

We warrant this product against defects or malfunctions in materials and workmanship, and against failure to conform to this product's written specifications, all for one year (1) from the date of original purchase by you. WE MAKE NO OTHER EXPRESS WARRANTY OR REPRESENTATION OF ANY KIND WHATSOEVER CONCERNING THIS PRODUCT. Your remedies under this warranty will be available so long as you can show in a reasonable manner that any defect or malfunction in materials or workmanship, or any non-conformity with the product's written specifications, occurred within one year from the date of your original purchase, which must be substantiated by a dated sales receipt or sales slip. Any such defect, malfunction, or non-conformity which occurs within one year from your original purchase date will either be repaired without charge or be replaced with a new product identical or reasonably equivalent to this product, at our option, within a reasonable time after our receipt of the product. If such defect, malfunction, or non-conformity remains after a reasonable number of attempts to repair by us, you may elect to obtain without charge a replacement of the product or a refund for the product. THIS REPAIR, REPLACEMENT, OR REFUND (AS JUST DESCRIBED) IS THE EXCLUSIVE REMEDY AVAILABLE TO YOU AGAINST US FOR ANY DEFECT, MALFUNCTION, OR NON-CONFORMITY CONCERNING THE PRODUCT OR FOR ANY LOSS OR DAMAGE RESULTING FROM ANY OTHER CAUSE WHATSOEVER. WE WILL NOT UNDER ANY CIRCUMSTANCES BE LIABLE TO ANYONE FOR ANY SPECIAL, CONSEQUENTIAL, INCIDENTAL, OR OTHER INDIRECT DAMAGE OF ANY KIND.

Some states do not allow the exclusion or limitation of incidental or consequential damages, so the above limitations or exclusions may not apply to you.

This warranty does NOT apply in the following circumstances: (1) when the product has been serviced or repaired by anyone other than us, (2) when the product has been connected, installed, combined, altered, adjusted, or handled in a manner other than according to the instructions furnished with the product, (3) when any serial number has been effaced, altered, or removed, or (4) when any defect, problem, loss, or damage has resulted from any accident, misuse, negligence, or carelessness, or from any failure to provide reasonable and necessary maintenance in accordance with the instructions of the owner's manual for the product.

We reserve the right to make changes or improvements in our products from time to time without incurring the obligation to install such improvements or changes on equipment or items previously manufactured.

This warranty gives you specific legal rights and you may also have other rights which may vary from state to state.

REMINDER: You must retain the sales slip or sales receipt proving the date of your original purchase in case warranty service is ever required.

**EAGLE ELECTRONICS
PO BOX 669
CATOOSA, OK 74015
800-324-1354**

DATUMS

WGS 84 WGS 1984
 DEFAULT Default

ADINDAN Adindan
 MEAN Mean for Ethiopia, Sudan

ADINDAN Adindan
 BURKINA Burkina Faso
 FASO

ADINDAN Adindan
 CAMEROON Cameroon

ADINDAN Adindan
 ETHIOPIA Ethiopia

ADINDAN Adindan
 MALI Mali

ADINDAN Adindan
 SENEGAL Senegal

ADINDAN Adindan
 SUDAN Sudan

AFGOOYE Afgooye
 SOMALIA Somalia

AIN EL ABD Ain el Abd 1970
 1970 Bahrain
 BAHRAIN

AIN EL ABD Ain el Abd 1970
 1970 SAUDI Saudi Arabia
 ARABIA

ANNA 1 ASTRO Anna 1 Astro 1965
 1965 COCOS Cocos Islands
 ISLANDS

ANTIGUA Antigua Island Astro 1943
 ISLAND Antigua (Leeward Islands)
 ASTRO 1943

ARC 1950 Arc 1950
 MEAN Mean for Botswana, Lesotho,
 Malawi, Swaziland, Zaire, Zambia,
 Zimbabwe

ARC 1950 Arc 1950 - Botswana
 BOTSWANA

ARC 1950 Arc 1950 - Burundi
 BURUNDI

ARC 1950 Arc 1950 - Lesotho
 LESOTHO

ARC 1950 Arc 1950 - Malawi
 MALAWI

ARC 1950 Arc 1950 - Swaziland
 SWAZILAND

ARC 1950 Arc 1950 - Zaire
 ZAIRE

ARC 1950 Arc 1950 - Zambia
 ZAMBIA

ARC 1950 Arc 1950 - Zimbabwe
 ZIMBABWE

ARC 1960 Arc 1960 - Mean for Kenya,
 MEAN Tanzania

ASCENSION Ascension Island 1958 -
 ISLAND Ascension Island
 1958

ASTRO BEACON .. Astro Beacon E 1945 - Iwo Jima
 E 1945
 IWO JIMA

ASTRO DOS 714 .. Astro DOS 71/4 - St Helena Island
 ST HELENA
 ISLAND

ASTRO TERN Astro Tern Island (FRIG) 1961 -
 ISLAND Tern Island
 1961

ASTRONOMICAL .. Astronomical Station 1952 -
 STATION '52 Marcus Island
 MARCUS ISLE

AUSTRALIAN Australian Geodetic 1966 -
 GEODETIC Australia & Tasmania
 1966

AUSTRALIAN Australian Geodetic 1984 -
 GEODETIC Australia & Tasmania
 1984

AYABELLE Ayabelle Lighthouse - Djibouti
 LIGHTHOUSE
 DJIBOUTI

BELLEVUE Bellevue (IGN) - Efate &
 (IGN) EFATE Erromango Islands
 ERRAOMANGO

BERMUDA Bermuda 1957 - Bermuda
 1957

BISSAU Bissau - Guinea-Bissau
 GUINEA

BOGOTA Bogota Observatory - Colombia
 OBSERVATORY
 COLOMBIA

BUKIT RIMPAH Bukit Rimpah - Indonesia (Bangka
 INDONESIA & Belitung Islands)

CAMP AREA Camp Area Astro - Antarctica
 ASTRO (McMurdo Camp Area)
 ANTARCTICA

CAMPO Campo Inchauspe - Argentina
 INCHAUSPE
 ARGENTINA

CANTON ASTRO .. Canton Astro 1966 - Phoenix
 '66 PHOENIX Islands
 ISLANDS

CAPE Cape - South Africa
 SOUTH
 AFRICA

CAPE Cape Canaveral - Bahamas,
 CANAVERAL Florida
 BAHAMAS FL

CARTHAGE	Carthage - Tunisia	EUROPEAN	European 1950
TUNISIA		1950 ITALY	Italy (Sardinia)
CH-1903	Switzerland	(SARDINIA)	
CHATHAM	Chatham Island Astro 1971	EUROPEAN	European 1950
ISLAND ASTRO	New Zealand (Chatham Island)	1950 ITALY	(Sicily)
NEW ZEALAND		(SICILY)	
CHUA ASTRO	Chua Astro	EUROPEAN	European 1950
PARAGUAY	Paraguay	1950	Malta
CORREGO	Corrego Alegre	MALTA	
ALEGRE	Brazil	EUROPEAN	European 1950
BRAZIL		1950 SPAIN	Portugal, Spain
DABOLA	Dabola	PORTUGAL	
GUINEA	Guinea	EUROPEAN	European 1979
DJAKARTA	Djakarta (Batavia)	1979	Mean for Austria, Finland,
(BATAVIA)	Indonesia (Sumatra)	MEAN	Netherlands, Norway, Spain,
INDONESIA			Sweden, Switzerland
DOS 1968	DOS 1968	FORT THOMAS	Fort Thomas, 1955
NEW GEORGIA	New Georgia Islands	1955 NEVIS	Nevis, St. Kitts
ISLANDS	(Gizo Island)	ST. KITTS	(Leeward Islands)
EASTER	Easter Island 1967	GAN 1970	Gan 1970
ISLAND	Easter Island	REPUBLIC OF	Republic of Maldives
1967		MALDIVES	
EUROPEAN	European 1950	GEODETIC	Geodeic Datum 1949
1950 MEAN	Mean for Austria, Belgium,	DATUM 1949	New Zealand
WESTERN	Denmark, Finland, France,	NEW ZEALAND	
	West Germany, Gibraltar, Greece,	GRACIOSA	Graciosa Base SW 1948
	Italy, Luxembourg, Netherlands,	BASE SW	Azores (Faial, Graciosa, Pico,
	Norway, Portugal, Spain, Sweden,	1948 AZORES	Sao Jorge, Terceira)
	Switzerland	GUAM	Guam 1963
EUROPEAN	European 1950	1963	Guam
1950 MEAN	Mean for Austria, Denmark,	GUNUNG	Gunung Segara
CENTRAL	France, West Germany,	SEGARA	Indonesia (Kalimantan)
	Netherlands, Switzerland	INDONESIA	
EUROPEAN	European 1950	GUX 1 ASTRO	GUX 1 Astro
1950 MEAN	Mean for Iraq, Israel, Jordan,	GUADALCANAL	Guadalcanal Island
MIDDLE EAST	Lebanon, Kuwait,	ISLAND	
	Saudi Arabia, Syria	HERAT NORTH	Herat North
EUROPEAN	European 1950	AFGHANISTAN	Afghanistan
1950	Cyprus	HJORSEY	Hjorsey 1955
CYPRUS		1955	Iceland
EUROPEAN	European 1950	ICELAND	
1950	Egypt	HONG KONG	Hong Kong 1963
EGYPT		1963	Hong Kong
EUROPEAN	European 1950	HU-TZU-SHAN	Hu-Tzu-Shan
1950 GREAT	England, Channel Islands, Ireland,	TAIWAN	Taiwan
BRITAIN	Scotland, Shetland Islands	INDIAN	Indian
EUROPEAN '50	European 1950	BANGLADESH	Bangladesh
FINLAND	Finland, Norway	INDIAN	Indian
NORWAY		INDIA NEPAL	India, Nepal
EUROPEAN	European 1950	INDIAN 1954	Indian - 1954
1950	Greece	THAILAND	Thailand, Vietnam
GREECE		VIETNAM	
EUROPEAN	European 1950	INDIAN 1975	Indian - 1975
1950	Iran	THAILAND	Thailand
IRAN			

IRELAND	Ireland 1965	NAHRWAN	Nahrwan
1965	Ireland	OMAN	Oman (Masirah Island)
ISTS 061	ISTS 061 Astro 1968	NAHRWAN	Nahrwan
ASTRO 1968	South Georgia Islands	SAUDI ARABIA	Saudi Arabia
S GEORGIA		NAHRWAN	Nahrwan
ISTS 073	ISTS 073 Astro 1969	UNITED ARAB	United Arab Emirates
ASTRO 1969	Diego Garcia	EMIRATES	
DIEGO GARCIA		NAPARIMA BWI	Naparima BWI
JOHNSTON	Johnston Island 1961	TRINIDAD AND	Trinidad & Tobago
ISLAND	Johnston Island	TOBAGO	
1961		N AMERICA	North American 1927
KANDAWALA	Kandawala	1927 MEAN	Mean for Antigua, Barbados, Barbuda,
SRI LANKA	Sri Lanka	CARRIBEAN	Caicos Islands, Cuba, Dominican
KERGUELEN	Kerguelen Island 1949		Republic, Grand Cayman, Jamaica,
ISLAND	Kerguelen Island		Turks Islands
1949		N AMERICA	North American 1927
KERTAU 1948	Kertau 1948	1927 MEAN	Mean for Belize, Costa Rica,
W MALAYSIA	West Malaysia & Singapore	CENTRAL AMER	El Salvador, Guatemala, Honduras,
SINGAPORE			Nicaragua
KUSAIE ASTRO ...	Kusaie Astro 1951	N AMERICA	North American 1927
CAROLINE 1951	Caroline Islands	1927 MEAN	Mean for Canada
ISLANDS		CANADA	
L C 5 ASTRO	L.C. 5 Astro 1961	N AMERICA	North American 1927
1961 CAYMAN	Cayman Brac Island	1927 MEAN	Mean for CONUS
BRAC ISLAND		CONUS	(Continental United States)
LEIGON	Leigon	N AMERICA	North American 1927
GHANA	Ghana	1927 MEAN	Mean for CONUS (East of Mississippi
LIBERIA	Liberia 1964	CONUS EAST	River) including Louisiana, Missouri,
1964	Liberia		Minnesota
LUZON	Luzon	N AMERICA	North American 1927
PHILIPPINES	Philippines	1927 MEAN	Mean for CONUS
	(Excluding Mindanao)	CONUS WEST	(West of Mississippi River)
LUZON	Luzon	N AMERICA	North American 1927
PHILIPPINES	Philippines (Mindanao)	1927 ALASKA	Alaska
MINDANAO		N AMERICA	North American 1927
MAHE ISLAND	Mahe 1971	1927 BAHAMAS	Bahamas
1971	Mahe Island	(NO SAN SALV)	(Except San Salvador Island)
MASSAWA	Massawa	N AMERICA	North American 1927
ETHIOPIA	Ethiopia (Eritrea)	1927 BAHAMAS	Bahamas (San Salvador Island)
(ERITREA)		N AMERICAN	North American 1927
MERCHICH	Merchich	1927 CANADA	Canada (Alberta, British Columbia)
MOROCCO	Morocco	(WEST)	
MIDWAY ASTRO ...	Midway Astro 1961	N AMERICAN	North American 1927
1961	Midway Islands	1927 CANADA	Canada (Manitoba, Ontario)
MINNA	Minna	(CENTRAL)	
CAMEROON	Cameroon	N AMERICAN	North American 1927
MINNA	Minna	1927 CANADA	Canada (New Brunswick,
NIGERIA	Nigeria	EAST	Newfoundland, Nova Scotia, Quebec)
MONTSERRAT	Montserrat Island Astro 1958	N AMERICAN	North American 1927
ISLAND	Montserrat	1927 CANADA	Canada (Northwest Territories,
ASTRO 1958	(Leeward Islands)	NORTH	Saskatchewan)
M'PORALOKO	M'Poraloko	N AMERICAN	North American 1927
GABON	Gabon	1927 CANADA	Canada (Yukon)
		YUKON	

N AMERICAN North American 1927	PITCAIRN Pitcairn astro 1967
1927 CANAL Canal Zone	ASTRO Pitcairn Island
ZONE	1967
N AMERICAN North American 1927	POINT 58 Point 58
1927 CUBA Cuba	BURKINA Mean for Burkina Faso & Niger
N AMERICAN North American 1927	FASO NIGER
1927 Greenland (Hayes Peninsula)	POINTE NOIRE Pointe Noire 1948
GREENLAND	1948 CONGO Congo
N AMERICAN North American 1927	PORTO SANTO Porto Santo 1936
1927 MEXICO Mexico	1936 MADEIRA Porto Santo, Madeira Islands
N AMERICAN North American 1983	ISLANDS
1983 ALASKA Alaska, Canada, CONUS	PROVISIONAL Provisional S. American 1956
CANADA CONUS	S AMERICA Mean for Bolivia, Chile, Colombia,
N AMERICAN North American 1983	1956 MEAN Ecuador, Guyana, Peru, Venezuela
1983 CENTRAL Central America, Mexico	PROVISIONAL Provisional S. American 1956
AM MEXICO	S AMERICA Bolivia
OBSERVATORIA ... Observaorio Metereo 1939	1956 BOLIVIA
METEREO Azores (Corvo & Flores Islands)	PROVISIONAL Provisional S. American 1956
1939 AZORES	S AMERICA Chile (Northern, Near 19°S)
OLD EGYPTIAN Old Egyptian 1907	1956 N CHILE
1907 EGYPT Egypt	PROVISIONAL Provisional S. American 1956
OLD HAWAIIAN Old Hawaiian	S AMERICA Chile (Southern, Near 43°S)
MEAN Mean for Hawaii, Kauai,	1956 S CHILE
Maui, Oahu	PROV S AMER Provisional S. American 1956
OLD HAWAIIAN Old Hawaiian	1956 Colombia
HAWAII Hawaii	COLOMBIA
OLD HAWAIIAN Old Hawaiian	PROVISIONAL Provisional S. American 1956
KAUAI Kauai	S AMERICA Ecuador
OLD HAWAIIAN Old Hawaiian	1956 ECUADOR
MAUI Maui	PROVISIONAL Provisional S. American 1956
OLD HAWAIIAN Old Hawaiian	S AMERICA Guyana
OAHU Oahu	1956 GUYANA
OMAN Oman	PROVISIONAL Provisional S. American 1956
ORD SURVEY Ordinance Survey	S AMERICA Peru
G BRITAIN Great Britain 1936 - Mean for	1956 PERU
1936 MEAN England, Isle of Man, Scotland,	PROVI S AMER Provisional S. American 1956
Shetland Islands, Wales	1956 Venezuela
ORD SURVEY Ordinance Survey	VENEZUELA
G BRITAIN Great Britain 1936 - England	PROVISIONAL Provisional S. American 1956
1936 ENGLAND	S CHILEAN Chile (South, Near 53°S) (Hito XVIII)
ORD SURVEY G ... Ordinance Survey	1963 S CHLIE
BRITAIN 1936 Great Britain 1936 - England,	PUERTO RICO Puerto Rico
ENGLND WALES Isle of Man, Wales	VIRGIN Puerto Rico, Virgin Islands
ORD SURVEY G ... Ordinance Survey	ISLANDS
BRITAIN 1936 Great Britain 1936 - Scotland,	QATAR Qatar National
SCOTLAND Shetland Islands	NATIONAL Qatar
ORD SURVEY Ordinance Survey	QORNOQ Qornoq
G BRITAIN Great Britain 1936 - Wales	GREENLAND Greenland (South)
1936 WALES	(SOUTH)
PICO DE Pico de las Nieves	REUNION Reunion
LAS NIEVES Canary Islands	MASCARENE Mascarene Islands
CANARY ISLES	ISLANDS
	ROME 1940 Rome 1940
	ITALY Italy (Sardinia)
	(SARDINIA)

RT 90Sweden

SANTO (DOS)Santo (DOS)
 '65 ESPIRITO 1965 Espirito Santo Island
 SANTO ISLAND

SAO BRAZSao Braz
 AZORES Azores (Sao Miguel,
 Santa Maria Islands)

SAPPER HILLSapper Hill 1943
 1943 EAST East Falkland Island
 FALKLAND ISLE

SCHWARZECKSchwarzeck
 NAMIBIA Nambia

SELVAGEM Selvagem Grande
 GRANDE Salvage Islands
 SALVAGE ISLE

SOVIETSGS 85
 GEODETIC Soviet Geodetic System 1985
 SYSTEM 1985

S AMERICANSouth American 1969
 1969 MEAN Mean for Argentina, Bolivia,
 Brazil, Chile, Colombia, Ecuador,
 Guyana, Paraguay, Peru,
 Trinidad & Tobago, Venezuela

S AMERICANSouth American 1969
 1969 ARGENTINA Argentina

S AMERICANSouth American 1969
 1969 BOLIVIA Bolivia

S AMERICANSouth American 1969
 1969 BRAZIL Brazil

S AMERICANSouth American 1969
 1969 CHILE Chile

S AMERICANSouth American 1969
 1969 COLOMBIA Colombia

S AMERICANSouth American 1969
 1969 ECUADOR Ecuador

S AMERICANSouth American 1969
 1969 ECUADOR Ecuador (Baltra, Galapagos)
 GALAPAGOS

S AMERICANSouth American 1969
 1969 GUYANA Guyana

S AMERICANSouth American 1969
 1969 PARAGUAY Paraguay

S AMERICANSouth American 1969
 1969 PERU Peru

S AMERICANSouth American 1969
 1969 TOBAGO Trinidad & Tobago
 AND TRINIDAD

S AMERICANSouth American 1969
 1969 VENEZUELA Venezuela
 VENEZUELA

SOUTH ASIASouth Asia

SINGAPORESingapore

TANANARIVETananarive Observatory 1925
 OBSERVATORY Madagascar
 1925
 MADAGASCAR

TIMBALAITimbalai 1948
 1948 BRUNEI Brunei, East Malaysia
 E MALAYSIA (Sabah, Sarawak)

TOKYOTokyo
 MEAN Mean for Japan, Korea, Okinawa

TOKYOTokyo
 JAPAN Japan

TOKYOTokyo
 KOREA Korea

TOKYOTokyo

OKINAWAOkinawa

TRISTAN DATristan Astro 1968
 CUNHA Tristan da Cunha
 ASTRO 1968

VITI LEVUViti Levu 1916
 1916 FIJI Fiji (Viti Levu Island)

WAKEWake

ENIWETOK '60Eniwetok 1960

MARSHALL ISLMarshall Islands

WAKE ISLANDWake Island Astro 1952
 ASTRO 1952 Wake Atoll

WGS 1972WGS 1972
 GLOBAL Global Definition
 DEFINITION

YACAREYacare
 URUGUAY Uruguay

ZANDERIJZanderij
 SURINAME Suriname

EAGLE DATABASES LICENSE AGREEMENT

THIS IS A LEGAL AGREEMENT BETWEEN THE END-USER WHO FIRST PURCHASES THIS PRODUCT AS A CONSUMER ITEM FOR PERSONAL, FAMILY, OR HOUSEHOLD USE (“YOU”) AND EAGLE ELECTRONICS, THE MANUFACTURER OF THIS PRODUCT. (“WE”, “OUR”, OR “US”). USING THE PRODUCT ACCOMPANIED BY THIS LICENSE AGREEMENT CONSTITUTES ACCEPTANCE OF THESE TERMS AND CONDITIONS.

1. This License Agreement applies to the one or more databases that your product may contain. We refer to these singly as a “Database” and together as the “Databases.” Your product may thus include the “WBS Database” which contains worldwide background surface mapping data, the “SmartMap Database” which contains inland mapping data, or other Databases.
2. The Databases that your product may contain are licensed, not sold. We grant to you the nonexclusive, nonassignable right to use these Databases for supplemental navigation reference purposes, but only as long as you comply with the terms and conditions of this License Agreement. We reserve the right to terminate this license if you violate any aspect of this License Agreement. You are responsible for using official government charts and prudent navigation for safe travel.
3. The Databases housed in your product are protected by the copyright notices appearing on the product or its screen(s). You may NOT modify, adapt, translate, reverse engineer, decompile, disassemble, rent, lease, or resell any Database, and you may NOT create derivative works based upon any Database or its contents.. Any unauthorized reproduction, use, or transfer of a Database may be a crime and may subject you to damages and attorney fees.
4. This License Agreement will terminate immediately without prior notice from us if you fail to comply with or violate any of the provisions of this Agreement. Upon termination, you will promptly return all products containing one or more Databases to us.
5. Prices and programs are subject to change without notice.
6. This License Agreement shall be governed by the laws of the State of Oklahoma and comprises the complete and exclusive understanding between you and us concerning the above subject matter.

DATABASES LIMITED WARRANTY

“We”, “our”, or “us” refers to Eagle Electronics, the manufacturer of this product. “You” or “your” refers to the first person who purchases the product as a consumer item for personal, family, or household use. The Databases Limited Warranty applies to the one or more databases that your product may contain. We refer to each of these as a “Database” or together as the “Databases.” Your product may thus include the “WBS Database” which contains worldwide background surface mapping data, the “SmartMap Database” which contains inland mapping data, or other Databases.

We warrant to you that we have accurately compiled, processed, and reproduced the portions of the source material on which the Databases are based. However, we are under no obligation to provide updates to the Databases, and the data contained in the Databases may be incomplete when compared to the source material. WE MAKE NO EXPRESS OR IMPLIED WARRANTY OF ANY KIND ABOUT THE ACCURACY OF THE SOURCE MATERIAL ITSELF, INCLUDING BUT NOT LIMITED TO IMPLIED WARRANTIES OF MERCHANTABILITY OR FITNESS FOR A PARTICULAR PURPOSE.

If there is a defect in any Database, your exclusive remedy shall be, at our option, either a refund of the price you paid for the product containing the defective Database or a replacement of such product. WE WILL NOT UNDER ANY CIRCUMSTANCES BE LIABLE TO ANYONE FOR ANY SPECIAL, CONSEQUENTIAL, INCIDENTAL, OR OTHER INDIRECT DAMAGE OF ANY KIND.

Some states do not allow the exclusion or limitation of incidental or consequential damages, so the above limitations or exclusions may not apply to you.

This warranty does NOT apply in the following circumstances: (1) when the product has been serviced or repaired by anyone other than us, (2) when the product has been connected, installed, combined, altered, adjusted, or handled in a manner other than according to the instructions furnished with the product, (3) when any serial number has been effaced, altered, or removed, or (4) when any defect, problem, loss, or damage has resulted from any accident, misuse, negligence, or carelessness, or from any failure to provide reasonable and necessary maintenance in accordance with the instructions of the owner's manual for the product.

We reserve the right to make changes or improvements in our products from time to time without incurring the obligation to install such improvements or changes on equipment or items previously manufactured.

This warranty gives you specific legal rights and you may also have other rights which may vary from state to state.

Your remedies under this warranty will be available so long as you can show in a reasonable manner that the defect occurred within one (1) year from the date of your original purchase, and we must receive your warranty claim no later than 30 days after such 1-year period expires. Your claim must be substantiated by a dated sales receipt or sales slip.

Notes:

How to Obtain Service (Canadian Customers Only)

We back your investment in quality products with quick, expert service and genuine Eagle replacement parts. If you need service or repairs, contact the Eagle Factory Customer Service Department at the toll-free number listed below. A technician may be able to solve the problem and save you the inconvenience of returning your unit. You will be asked for your unit's serial number.

800-324-1354

Canada Only. Monday through Friday 8:00 A.M. - 8:00 P.M. Central Time.

How to Obtain Service (International Customers Only)

If you need service or repairs, contact the dealer in the country you purchased your unit.

**WARRANTY REPAIR WILL BE HONORED ONLY IN THE COUNTRY
UNIT WAS PURCHASED.**

Please follow the shipping instructions shown below on this page if you have to mail your unit to the dealer. For proper testing, repair, and service, send a brief note with the product describing the problem. Be sure to include your name, return shipping address, and a daytime telephone number.

Shipping Information

When sending a product for repair, we recommend you do the following:

1. Always use the original shipping container and filler material the product was packed in when shipping your product.
2. Always insure the parcel against damage or loss during shipment. Eagle does not assume responsibility for goods lost or damaged in transit.
3. For proper testing, repair, and service, send a brief note with the product describing the problem. Be sure to include your name, return shipping address, and a daytime telephone number.

Accessory Ordering Information

To order accessories such as power cables or transducers, please contact:

1. Your local marine dealer. Most quality dealers that handle marine electronic equipment should be able to assist you with these items. Consult your local telephone directory for listings.
2. Canadian customers only can write:
Lowrance/Eagle Canada, 919 Matheson Blvd., E. Mississauga, Ontario L4W2R7
or fax 905-629-3118

How to Obtain Service (U.S.A. Only)

We back your investment in quality products with quick, expert service and genuine Eagle replacement parts. If you're in the United States and you have questions, please contact the Factory Customer Service Department using our toll-free number listed below. You must send the unit to the factory for warranty service or repair. Please call the factory before sending the unit. You will be asked for your unit's serial number (shown above). Use the following toll-free number:

800-324-1354

U.S.A. only. Monday through Friday 8:00 A.M. - 8:00 P.M. Central time, except holidays.

Your unit is covered by a full one-year warranty. (See inside for complete warranty details.) If your unit fails and the failure is not covered by the original warranty, Eagle has a flat-rate repair policy that covers your unit and accessories packed with the unit at the factory. There is a 180-day warranty on all non-warranty repairs from the factory, which is similar to the original warranty, but is for 180 days rather than one year. For further details, please call us at the above number.

Eagle also gives you free UPS shipping from anywhere in the continental United States both to and from the factory for all warranty repairs. You can also use the enclosed UPS shipping label for non-warranty shipments. See inside for more information.

Remember, non-warranty repairs are subject to Eagle's published flat-rate charges and 180-day warranty.