



AccuNav II

INSTALLATION AND OPERATION INSTRUCTIONS



LITHO IN U.S.A.

988-0129-18

WARNING!

USE THIS GPS RECEIVER ONLY AS AN AID TO NAVIGATION. A CAREFUL NAVIGATOR NEVER RELIES ON ONLY ONE METHOD TO OBTAIN POSITION INFORMATION.

CAUTION

This GPS receiver, (like all GPS navigation equipment) will show the shortest, most direct path to a waypoint. It provides navigation data to the waypoint regardless of obstructions. Therefore, the prudent navigator will not only take advantage of all available navigation tools when travelling to a waypoint, but will also visually check to make certain a clear, safe path to the waypoint is always available.

NOTICE!

As of this writing, the Department of Defense (DOD) has not declared the GPS navigation system operational. The system is still in a testing phase. Satellites can be turned off or accuracy can be degraded at will by the system operators. Remember that the AccuNav II, or any GPS receiver is only as accurate as the system it's using.

Copyright © 1993 Eagle Electronics
All rights reserved.

All features and specifications subject to change without notice.
All screens in this manual are simulated.

DTG MI 0.12	BEARING U N 280°
XTE MI R 0.06	TTG HH:MM:SS 00:00:20

GROUP "H"

TABLE OF CONTENTS

INSTALLATION	1
POWER CONNECTIONS	2
GPS MODULE INSTALLATION	3
KEYBOARD	6
GPS - HOW IT WORKS	7
ACCURACY	8
THE EAGLE GPS MODULE	8
GETTING STARTED - INITIALIZATION	9
CHANGE POSITION	10
CHANGE ALTITUDE	10
CHANGE TIME	10
CHANGE DATE	11
COLD START	11
POSITION/NAVIGATION DISPLAYS	12
SATELLITE INFORMATION SCREEN	12
POSITION SCREEN	13
STEERING SCREEN	14
NAVIGATION SCREEN	15
CUSTOMIZE SCREENS	15
PLOTTER	16
PLOTTER CURSOR	17
PLOTTING WITH A WAYPOINT	17
PLOTTER MENUS	18
PLOTTER MENU - PAGE 1	18
CLEAR PLOT	18
SET RANGE	19
ICON ON/OFF	19
ALARMS	19
GOTO CURSOR	19
CHANGE DISPLAY	20
PLOTTER MENU - PAGE 2	20
SELECT UNITS OF MEASURE	20
BACK LIGHT ON/OFF	21
GRID LINES	21
PLOTTER UPDATE	22
EVENT MARKER	22
USING THE EVENT MARKER WITH THE CURSOR	22
ERASING ICONS	23
HELP	23
WINDOWS	24
VIEWING WINDOWS OPTIONS	25
WAYPOINT NAVIGATION	25
HOW TO SAVE A WAYPOINT	26
QUICK SAVE METHOD	26
VIEW AND SAVE METHOD	26
ENTER NEW WAYPOINT	27
NAME A WAYPOINT	27
ERASE A WAYPOINT	28
RECALL A WAYPOINT	28
ROUTES	29
CREATING A ROUTE	29
NAME A ROUTE	30
WAYPOINT SELECTION	30
FOLLOWING A ROUTE	31
CANCEL NAVIGATION	32
MODIFYING A ROUTE	32
ERASING A ROUTE	33
GPS ALARMS	33
ARRIVAL ALARM	35
XTE (CROSS TRACK ERROR) ALARM	35
ANCHOR ALARM	35
CHANGING GPS SETTINGS	35

TABLE OF CONTENTS (cont.)

SELECT NMEA/DGPS RECEIVER	36
TRUE AND MAGNETIC POSITION	38
PRESET	39
MAN OVERBOARD	39
PCF OFFSET	41
GPS MODULE SELF-TEST	43
GPS SIMULATOR	43
SPECIFICATIONS	44
WINDOWS SUMMARY	45

WINDOWS SUMMARY

All of the window groups used by the AccuNav II are shown on the following pages. To view these groups, simply press the WINDOWS key, then repeatedly press the down arrow key. This will "cycle" the unit through all groups.

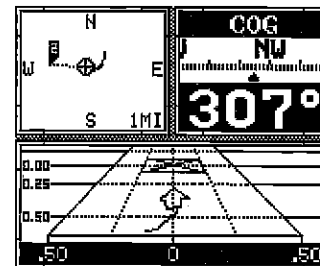

GROUP "A"

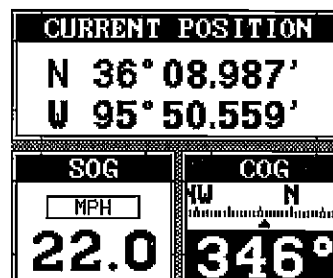

GROUP "B"

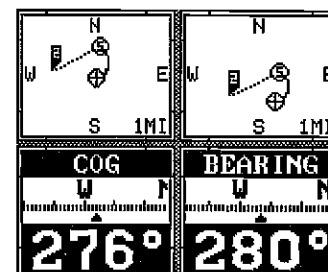

GROUP "C"

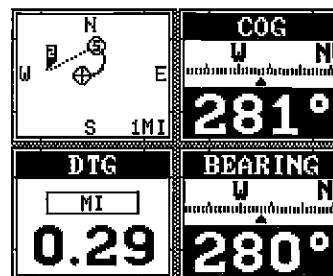

GROUP "D"

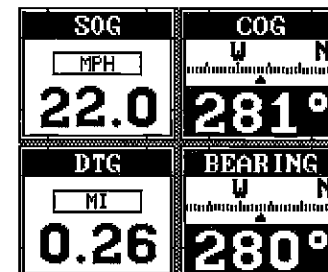

GROUP "E"

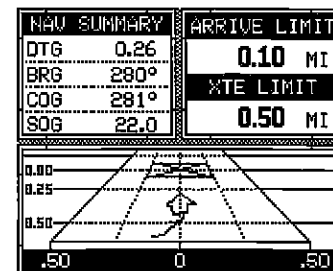

GROUP "F"

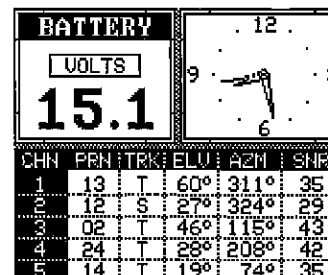

GROUP "G"

AccuNav II GPS RECEIVER SPECIFICATIONS

GPS Module Dimensions 2.5"H x 4.1"W x 7" D
Channels Five Parallel
Four continuous for position
All satellites in view tracked
Update rate One second
Accuracy Maximum accuracy achievable with
Standard Positioning Service
Position: 25 meters CEP
Velocity: 0.25 meters/sec RMS
Without SA PDOP<6.0

NMEA 0183 SENTENCES

RMB Minimum Recommended Sentence, Part B
RMC Minimum Recommended Sentence, Part C
GLL Present Position - Latitude/Longitude
APB Autopilot Steering Data

INTRODUCTION

The AccuNav II is a high quality, wide screen GPS receiver with performance that is second to none in its class. Using menu features and "soft-key" operation, the AccuNav II is also one of the easiest-to-use products Eagle has ever built. The wide "Ultravision" screen shows the navigation and plotter screens with high resolution and detail. The display and keyboard are also lighted for night operation. This unit is also differential GPS (DGPS) ready for superior accuracy.

Read this manual and take it with you the first few times you use your unit. It makes a great reference if you need it.

MOUNTING

Install the AccuNav II in any convenient location, provided there is clearance behind the unit when it is tilted for the best viewing angle. Holes in the bracket base allow wood screw or through-bolt mounting. You may need to place a piece of plywood on the back of thin fiberglass panels to secure the mounting hardware. Make certain there is enough room behind the unit to attach the power and GPS module cables.

The smallest hole that will pass one power or GPS module plug is one inch. After the hole is drilled, pass the GPS cable connector up through the hole first, then pass the power cable down through it.

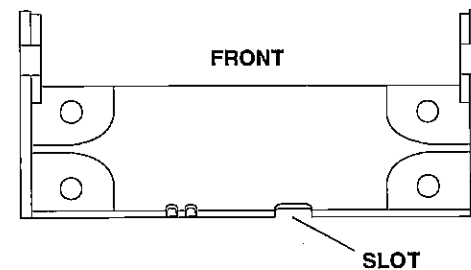

After the cables have been routed, fill the hole with a good marine sealing compound. Offset the bracket to cover the hole. Route the power and GPS module cables through the slot in the back of the bracket.

POWER CONNECTIONS

The AccuNav II works from a twelve-volt battery system. For the best results, attach the power cable directly to the battery. You can attach the power cable to an accessory or power buss, however you may have problems with electrical interference. Therefore, it's safer to go ahead and attach the power cable directly to the battery. If the cable is too short, splice #18 gauge wire onto it. The power cable has four wires; red, black, green, and white. Red is the positive lead, black is negative or ground. Make certain to attach the in-line fuse holder to the red lead as close to the power source as possible. For example, if you have to extend the power cable to the battery or power buss, attach one end of the fuse holder directly to the battery or power buss. This will protect both the unit and the power cable in the event of a short. The AccuNav II uses a 3-amp fuse.

IMPORTANT!

Do not use this product without a 3-amp fuse wired into the power cable! Failure to use a 3-amp fuse will void your warranty.

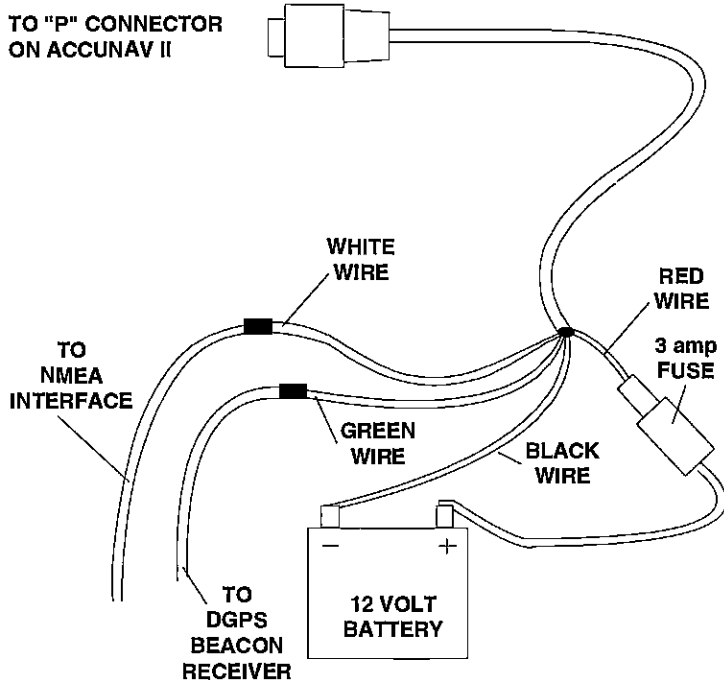

AccuNav II POWER CONNECTIONS

GPS MODULE SELF-TEST

This feature tests the GPS module and returns a special code. This code is of interest only to the service department. However, the AccuNav II interprets this code and displays a status message. This message is either "MODULE HAS PASSED" or "MODULE HAS FAILED" and shows at the bottom of the screen. The current software version number also appears near the bottom of the screen. Contact the factory customer service department if the module fails the self test. Do not attempt to use this product if it fails the self test.

To use the self test feature, press the MENU key twice while it's in the GPS mode, then press the key next to the "GPS MODULE SELF TEST" label. The screen shown at right appears.

To exit from this screen, press the CLEAR key.

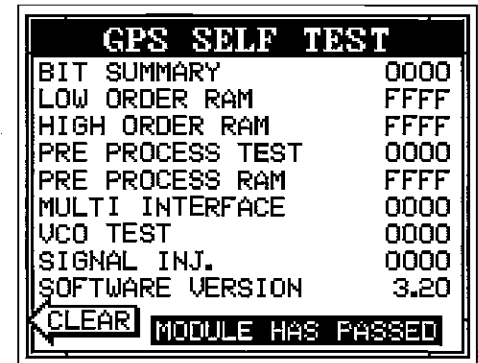

GPS SIMULATOR

This feature places position and navigation data on all screens, including the plotter. The unit "navigates" a closed course. It shows bearing and distance to go, course over ground, and other information. A recurring message appears, alerting you that the simulator mode is enabled. Don't navigate when the simulator is on!

To turn the simulator on, press the MENU key twice, then press the key next to the "GPS SIMULATOR OFF ON" label. The simulator mode starts immediately. To turn the simulator off, either press and hold the OFF key or repeat the above steps. Press the key next to the "GPS SIMULATOR OFF ON" label.

is the difference between the location shown on the present position display and the position shown on the chart.

Use the right and left arrow keys to move the black box to the number that you wish to change in the latitude, then enter the numbers.

Use the up or down arrow keys to change the latitude from north to south, if necessary. Press the key next to the "ACCEPT" label when you've entered the desired latitude offset.

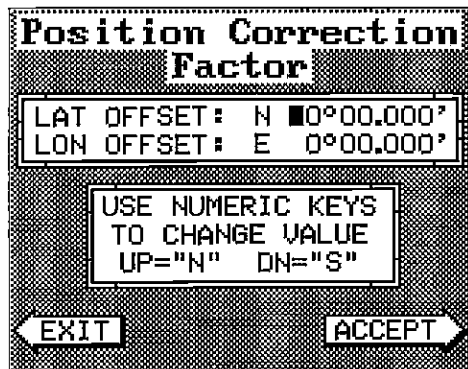

Repeat this procedure to change the longitude. In this example, we have entered .012 degrees north latitude and .068 degrees east longitude as the PCF offset. That is the difference between the present position shown on the unit and our position shown by the chart. In other words, our position shown on the unit is 0.012 degrees north and 0.068 degrees east of the position shown on the chart.

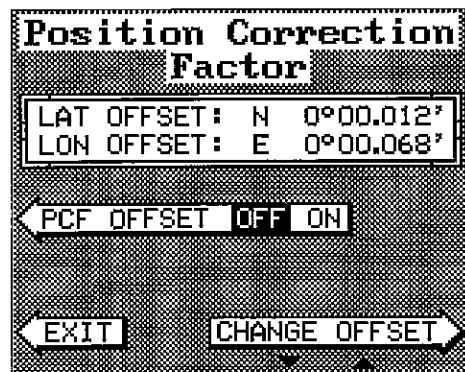

After you've entered the desired offset, press the key next to the "PCF OFFSET OFF ON" label. This turns the PCF correction factor that you entered on. To leave this screen, press the key next to the "EXIT" label. This returns the unit to the last used GPS screen. It also puts your changes into effect.

To turn these changes off, return to this screen and press the key next to the "PCF OFFSET OFF ON" label. Remember, Presetting the unit also erases any PCF offset, thereby turning it off.

The white and green wires are for a NMEA interface and a DGPS beacon receiver. The AccuNav II sends data to another electronic navigation devices through the white wire and receives data from a beacon receiver through the green wire. If the white and green wires are not used, tape their ends so that they cannot short.

To connect a device to the AccuNav's white or green wires, attach a shielded, twisted pair cable from the device's NMEA input to the white wire on the AccuNav II's power cable. Solder the ground conductor of the twisted pair and the shield to the black wire on the power cable. Do not connect the shield to the other device. See the other instrument's manual for more wiring instructions.

See the NMEA section in this manual for more information.

GPS MODULE INSTALLATION

The GPS module can be installed on a flat surface or (with the supplied adapter) on a pole. Mount the module in an area that guarantees a clear view of the sky at all times. In order for the module to receive the signals from the satellites, it must not be obstructed. An ideal location is on a cabin roof, or deck. The gunnels also make a good location. Attaching the pole mounting adapter lets you install the module on a one inch mast. However, for lightning protection, the antenna shouldn't be the highest part of the boat.

Surface Mounting - With Access

If you have access underneath the mounting surface, use the gasket supplied with the GPS module as a template. Drill four 5.5 mm (7/32") holes and one 17 mm (11/16") hole for the module's cable. Attach the cable to the module and pass it down through the hole in the gasket and the mounting surface. Use 5 mm screws, flat washers, and lock washers to fasten the GPS module to the mounting surface. Route the cable to the AccuNav II.

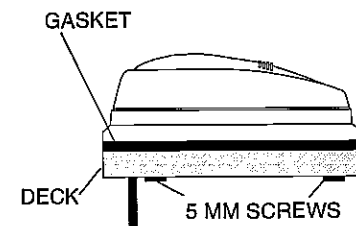
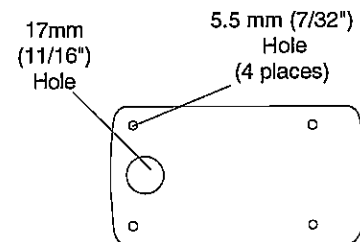

Surface Mounting - Without Access

If you don't have access to the back side of the mounting surface, use the "cleats" supplied with the AccuNav II. (Note: This is assuming you can "snake" the module's cable to a location that is accessible. A hole will still need to be drilled in the mounting surface for the cable.) Using the gasket as a template, mark and drill the 17 mm (11/16") hole for the cable. Attach the cable to the module and drop the other end of the cable through the gasket and down the hole. Place the module on the gasket. Slide the "cleats" onto each end of the module and (using the cleats as templates) mark four holes for 5 mm (#10) mounting screws. Drill the holes, then replace the cleats on the module and fasten them to the mounting surface with 5 mm (#10) screws. Route the cable to the AccuNav II.

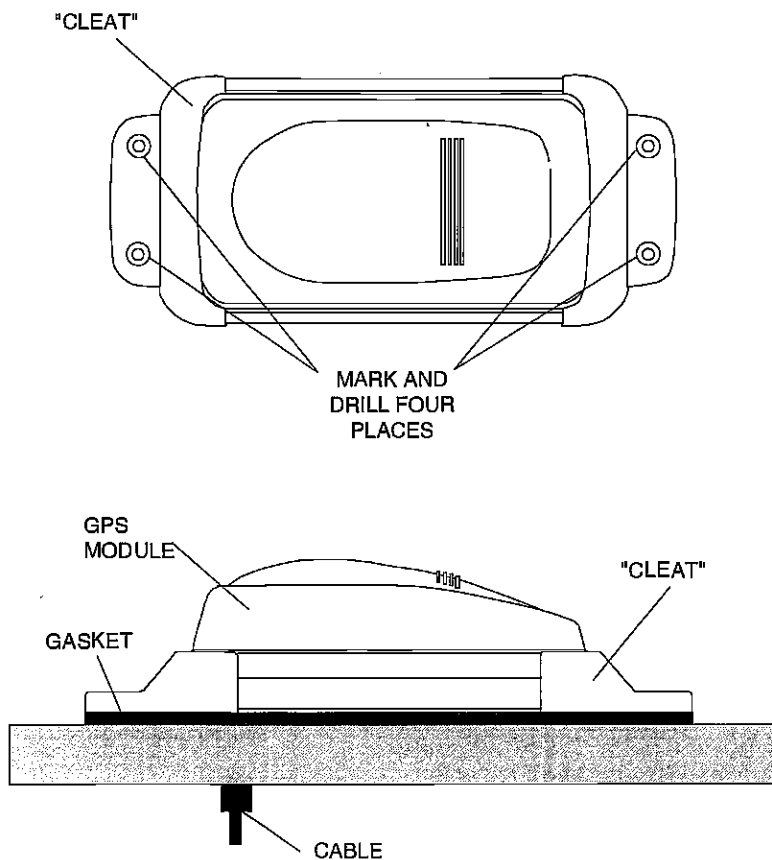

PCF OFFSET

The GPS navigation system relies on complex mathematical calculations to determine your position based on satellite data and other factors. One factor is the Earth's shape. Since the Earth is not a true sphere, variations in the calculations have to be made to accommodate deviations. To make matters more complex, not everyone uses the same data to determine what the deviations are. The size and shape of the ellipsoids that are used to approximate the earth's surface are improved often. This can lead to errors if your navigation device uses one ellipsoid, while your chart uses a different one. The term used for these ellipsoids is "Datum."

To reduce the error factor between datum, this unit gives you the capability to move or "offset" the position shown on the display to match the one on the chart. The unit will add this offset to all position displays at all times.

Remember, the GPS error is very dynamic and the PCF offset should never be used in an attempt to cancel the error. In general terms this feature should only be used if your map indicates what the possible error is. This feature should always be reset to zero (0) when finished with that chart.

For example, suppose you are stopped at a location that is accurately marked on a chart. Your unit shows a longitude position that is .010 degrees less than the one on the chart. Using the Position Correction Factor (PCF) Offset feature, you make the unit read the same as the chart. If you move, the unit will continuously add the change to all position displays. This makes it more closely match the datum used by the chart. For this reason, you should be careful when entering the PCF offset. This offset is saved in memory. It doesn't change when the unit is turned off. However, a Preset does erase the PCF factor.

To set the PCF factor, first press the MENU key, then press the key next to the "CHANGE GPS SETTINGS" label. Now press the key next to the "ADJUST PCF OFFSET" label. The screen shown below appears.

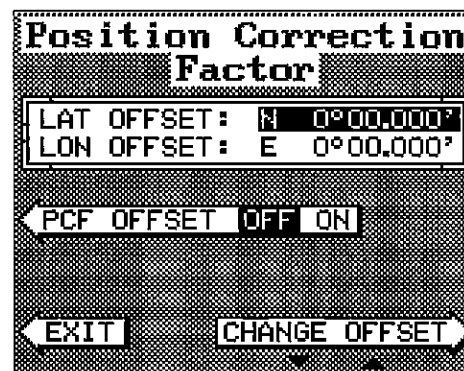

Now press the key adjacent to the "CHANGE OFFSET" label to enter the correction factor for your location. The screen shown at the top of the next page appears. Remember, this

The plotter display automatically shows a .1 mile display in the Man Overboard mode. Your position when the Man Overboard key was pressed is shown by the "S" with a circle and by the waypoint icon with a "0." Steer to the waypoint flag to get back to the position saved when the Man Overboard key was pressed.

IMPORTANT!

The AccuNav II doesn't save the Man Overboard position in the waypoint table. However, it does save the position on the Man Overboard screen.

The AccuNav II always shows navigation data to the position shown on the Man Overboard screen whenever the Man Overboard key is pressed. To stop the unit from navigating to the Man Overboard position, press the key next to the "DISABLE MOB" label. This resets the Man Overboard navigation.

For example, suppose you are viewing the Position screen, and you press the Man Overboard key, then press the GPS key. The AccuNav II first displays then stores your present position on the Man Overboard screen, then switches back to the Position screen. If you press the Man Overboard key again, it will still show navigation data to the position you were in when you first pressed the Man Overboard key - not your present position. Repeated pressing of the Man Overboard key does not repeatedly save your present position! The unit only saves the position the first time the Man Overboard key is pressed. To save a new Man Overboard position, you must first clear the old position by pressing the key adjacent to the "DISABLE MOB" label.

You can navigate to a waypoint using the Waypoint Recall feature, however when you go back to the Man Overboard screen, the AccuNav II stops navigating to the recalled waypoint.

Remember, saving the victim is the primary goal. Try all options to rescue the person immediately after the accident happens. Training and education are also good accident preventatives. The Coast Guard has excellent safety courses. Instruct all members on board your boat on safety procedures before leaving the dock. Make certain all on board know what to do before any emergency occurs.

Pole Mount

First, thread the pole mounting adapter onto the mounting pole or ratchet base. Align the pole mounting adapter so the module will face the bow of the boat. Install and tighten the set screw into the pole mounting adapter and tighten it securely. This should prevent the GPS module from unscrewing from the pole. Place the gasket onto the pole mounting adapter. Now attach the cable to the GPS module and pass the cable through the gasket, pole mounting adapter, and pole. Set the GPS module on top of the pole mounting adapter and align the four threaded holes in the module with the holes in the pole mounting adapter. Using the four stainless steel 5 mm screws and lock washers supplied with the AccuNav II, attach the pole mounting adapter to the GPS module. This completes the assembly.

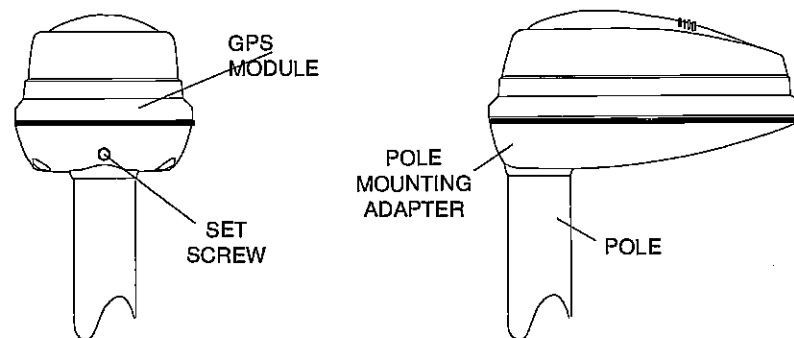

If the pole or mast you're using isn't hollow or if the hole in the middle of the pole is too small for the connectors, use the cable mounting adapter supplied with your unit. Thread the cable mounting adapter into the GPS pole mounting adapter. Then thread the pole into the cable mounting adapter. Route the cable down the outside of the pole.

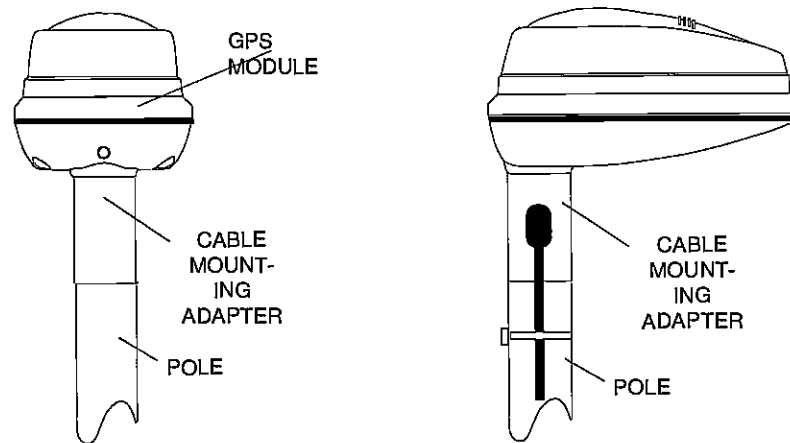

KEYBOARD

The keyboard has keys arranged in two vertical columns plus a horizontal row at the bottom. The keys in the left and right columns are used to enter numbers, activate the windows feature and menu selections.. The menu key in the bottom right corner of the keyboard activates the first menu page. The keys along the bottom of the screen are used to activate the event markers or man overboard feature, and make menu selections with the arrow keys.

WINDOWS - This key gives you access to the windows mode, which lets you customize displays.

POS - Press this key to show the Position Screen.

PLOT - This key gives access to the Plotter.

NAV - Pressing this key shows the Navigation Display.

STEER - Press this key to show the Steering Screen.

MENU - Press this key to show the menus and gain access to most functions

WAYPOINT QUICK SAVE - Press this key to instantly save your present position.

WAYPT SAVE - Pressing this key lets you save a waypoint.

WAYPT RECALL - Press this key to recall a waypoint.

ALARM - Use this key to set the GPS alarms.

CLEAR - This key clears menus and erases entries from the screen.

EVENT MARKER - To mark a location on the plotter screen, use this feature.

MAN OVERBOARD - Pressing this key instantly saves your present position and switches the unit into a mode that shows navigation data to the last saved position.

ARROW KEYS - These keys are used to make menu selections and to move objects on the screen.

ON - The ON key turns the AccuNav II on.

OFF - Press and **HOLD** the Off key to turn the AccuNav II off..

PRESET

The Preset feature returns all sonar and GPS units to their original factory settings. This resets the units of measure, speaker volume, display contrast, and more. This doesn't erase any waypoints or routes, however.

To preset the unit, press the MENU key until the "PRESET UNIT" label appears. Press the key next to that label. The menu screen disappears and the AccuNav II returns to the GPS position screen. All units will be returned to their factory settings.

MAN OVERBOARD

One of boating's most terrifying events is having a friend or family member fall overboard. This situation can be deadly on any body of water, fresh or salt. It's particularly dangerous at night or if you're out of sight of land. Of course, the first thing to do is remain calm and try all standard safety measures to try to rescue the person. If you lose sight of the person, you can use the AccuNav II to help start a search pattern.

Once you're back at the helm after initial rescue efforts have failed, press the AccuNav II's **MAN OVERBOARD** key. The screen shown below appears. Your position at the time you pressed the Man Overboard key is shown in the top left corner of the display. Beneath the position is the time that you pressed the Man Overboard key. At the bottom of the screen are the navigation data displays showing the Distance (DTG), Bearing (BRG), Course (COG), and Time To Go (TTG) back to the position at the top of the display. Using these displays along with the plotter in the lower right corner of the display gives you the information you need to steer back to the man overboard position.

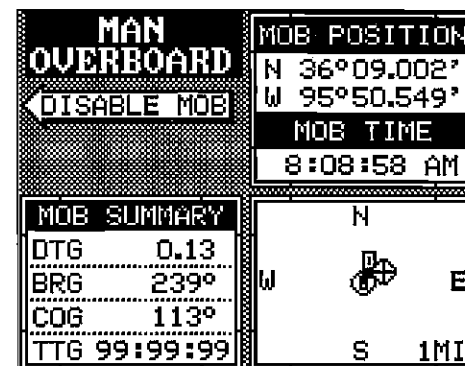

The lower half of the screen shows statistics for each of the receiver's five channels. This includes the satellite number (PRN), its status (STAT), the User Differential Range Error (UDRE), Time status (TIME), and if SA (Selective Availability) is on or off. The UDRE is the range error from your position to the satellite. If there is an "OK" in this field, then the range error to that satellite is 8 meters or less 68 percent of the time.

DAPS: ON					
STAT ID:	1	FREQ:	296.0		
HEALTH :	0	BIT :	100		
SIGNAL :	053	SNR :	31		
	PRN	STAT	UDRE	TIME	SA
1	15	OK	OK	OK	OFF
2	13	OK	OK	OK	OFF
3	02	OK	OK	OK	ON
4	27	OK	OK	OK	ON
5	26	BAD	OK	BAD	ON
← CLEAR					

For more information, read your beacon receiver's manual.

SELECT UNITS OF MEASURE

(See the Select Units of Measure in the Plotter section of this manual.)

TRUE and MAGNETIC POSITION

True and magnetic north are not always the same. True north is the top of the world. It's where all lines of longitude converge. Magnetic north is the location our compasses point. It lies several hundred miles to the south of true north, at a location in Canada.

Charts are usually laid out according to a Mercator projection that uses true north. If you plot a course on a chart using the Mercator projection, you'll either have to convert magnetic readings to true or use true readings.

The AccuNav II can display navigation information in magnetic or true. When it's turned on for the first time magnetic is used. To switch to true, press the MENU key while a GPS screen is displayed. Next, press the key next to the "CHANGE GPS SETTINGS" label. Now press the key next to the "SELECT UNITS OF MEASURE" label. Now simply press the key next to the "BEARING" label. This moves the black box from "MAG" to "TRU." Press the key next to the "EXIT" label when you're finished.

GPS - HOW IT WORKS

The Global Positioning System (GPS) is the best approach to navigation that has ever been devised. Conceived by the Department of Defense (DOD) and the United States military, the GPS system is an answer to their needs of 24 hour global positioning, 365 days a year.

Basically, the system works by using a constellation of satellites orbiting Earth 11,000 miles in space. There will be 21 satellites in orbit when the system is fully operational. Three more satellites will act as spares, for a total of 24. When all satellites are in place, at least four of them will be in view nearly anywhere on Earth twenty-four hours a day. The GPS receiver requires at least three satellites to give a "2D" fix. (A 2D fix is your position in latitude/longitude. A 3D fix is your latitude/longitude plus altitude.) When it locks on to at least four satellites, it displays a 3D fix.

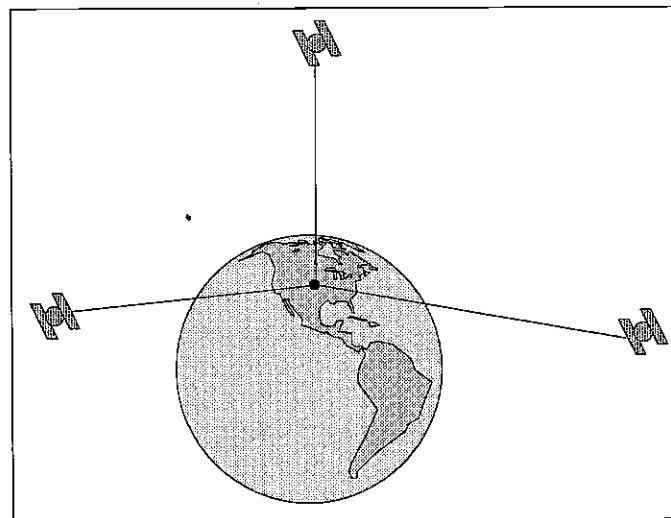

It takes three satellites to determine position.

As the receiver locks on to each satellite, it calculates the distance from the satellite by measuring the length of time it takes the radio signal to reach it. Each satellite has an extremely accurate clock that tells the receiver when the radio transmission started. The receiver compares that time against its own clock, thus it knows how long it took the radio signal (travelling at the speed of light!) to reach it. If you know time and speed, then you can calculate distance. Once you have this from three satellites, then the receiver can determine position.

ACCURACY

You may have heard tales of extraordinary accuracy from GPS receivers. The DOD requires accuracy of 10 to 15 meters from the satellite system. However, only the military gets this precision. The way the military keeps us and other unauthorized people from using the more precise system is coding. In other words, the data coming from the satellites is encrypted. Civilian GPS receivers use "C/A Code." It's accuracy is intentionally worse than the military's "P Code." In this manner, civilian users worldwide can benefit from excellent position fixes. Meanwhile, the military keeps the most accurate system away from potential enemies. Theoretically, C/A code can give accurate position fixes up to 15 meters. This is more than adequate for most people.

However (as of this writing), the military isn't satisfied with C/A's potential accuracy in the hands of the world. So, it's degrading it further with "Selective Availability" or SA. This is small, random errors intentionally added to the system so your accuracy will typically be within 100 meters. Of course, accuracy also depends on the angle of the satellite above the horizon, signal-to-noise ratio, the number of satellites tracked at one time (the more the better), and other factors. The smallest ranges on the plotter may not be usable if the SA is high. The present position symbol can move off the screen even while you're sitting still.

Don't let this discourage you, however. GPS by nature has much faster updates than other systems (such as Loran), and typically is much easier to use. Accuracy, even with SA on is still better than most other navigation systems. You've purchased one of the finest navigation instruments on the market today. We hope you'll enjoy it for many years to come.

The EAGLE EGP-1 GPS Module

This GPS receiver is currently used in all Eagle GPS receivers. It's small, rugged, and fast. The five channel design lets it track all satellites in view and acquire up to five satellites at one time. It sends position information to the AccuNav II once every second. By incorporating Rockwell's GPS receiver technology with Eagle's state-of-the-art design and manufacturing capabilities, Eagle brings to the consumer the most advanced line of GPS marine navigation systems available in the world.

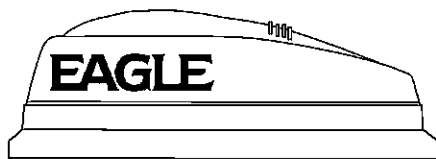

DGPS (Differential GPS) BEACON RECEIVER SETUP

You'll have to tell the AccuNav II which beacon receiver's data to expect and set up the parameters for that data. To do this, first press the MENU key, then press the key next to the "CHANGE GPS SETTINGS" label. Now press the key next to the "SELECT NMEA" label. The screen on the previous page appears. Press the key next to the desired beacon receiver. The beacon receiver is selected, now you'll need to set it up for the frequency and bit rate of the station you'll be using in your area.

Repeat the above steps to get the NMEA screen as shown on the previous page. Now press the key next to the "SETUP BEACON" label. The screen shown below appears.

The station frequency and bit rate are shown on the right side of the screen. Press the key adjacent to the "INC FREQ" to increase the station frequency or the "DEC FREQ" to decrease it. Do the same for the bit rate. When the station frequency and bit rate are adjusted to their proper settings, press the key next to the "EXIT" label. The

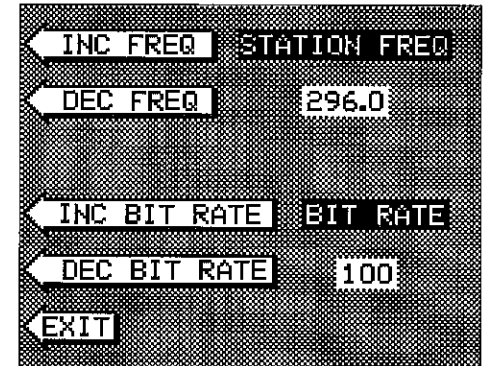

AccuNav II returns to the last used GPS screen. The letters "DGPS" appear next to the "POSITION" on all screens that show your present position, showing that the beacon receiver is working.

To view the status of the beacon signal, press the MENU key until the fourth menu page appears. Now press the key adjacent to the "DIFFERENTIAL GPS STATUS" label. If the beacon receiver is receiving data from the transmitter and is connected properly to the AccuNav II, a screen similar to the one shown at right appears.

This page shows the station ID number, its frequency and bit rate, the "health" of the station (0 = best, 5 = worst), signal strength (the higher the number, the better), and the signal-to-noise ratio (SNR). The higher the SNR number, the better.

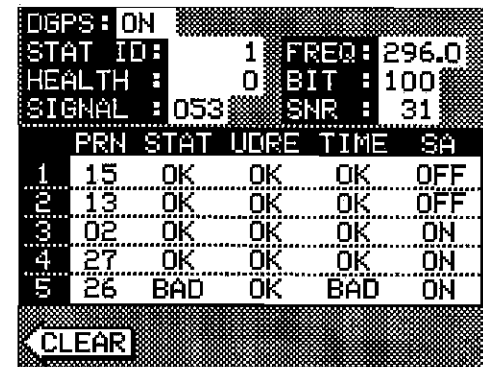

SELECT NMEA

The AccuNav II sends data out the white wire on the power cable according to standards set by the NMEA (National Marine Electronics Association). This allows the AccuNav II to send position, depth, and navigation information to "listener" units, such as charting instruments, autopilots, and other marine instruments. The AccuNav II uses the following NMEA data protocols: NMEA 0180 and 0183. NMEA 0180 sends steering information only. It's useful mainly for autopilots. NMEA 0183 sends depth, position, steering, speed, and more. In order to use this feature, the white wire on the power cable must be connected to the NMEA data input on the other instrument. See the installation section in the front of this manual for wiring connection information.

The AccuNav II also has the capability to receive differential data from a beacon receiver. This gives the unit much better accuracy than normal. However, before purchasing and installing a beacon receiver, make certain there are transmitters in the area you wish to use. Presently, the AccuNav II can use the Magnavox MRB-2A or StarLink MX-50R. Please note that the AccuNav II doesn't send NMEA 0183 data when the Magnavox MRB-2A beacon receiver is activated.

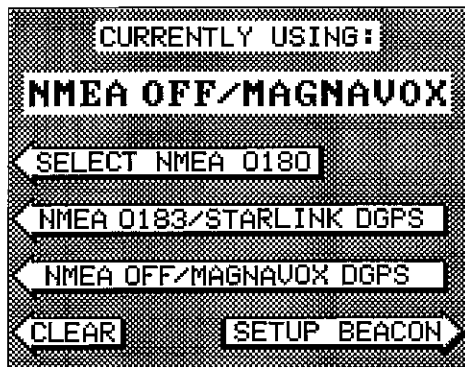

NMEA SETUP

Once you connect the wiring properly, the AccuNav II must be told which NMEA data format to use. Consult the owner's manual of the other equipment to see which format it needs. Then set the AccuNav II as follows:

First, press the MENU key. Next, press the key next to the "CHANGE GPS SETTINGS" label. Now press the key next to the "SELECT NMEA" label. The screen shown above appears.

The data format currently in use shows at the top of the screen. Press the key next to the desired data output. Now press the CLEAR key. The AccuNav II will return to the last used GPS screen and send NMEA data out the white wire on the power cable.

GETTING STARTED

Initialization - Power On

In order for the AccuNav II to lock onto the satellites, it must first find them. If you simply turn the unit on and wait, the unit will find the satellites by itself in 15 minutes or less. This is called "Cold Start." If you let it find the satellites, the time display will probably be wrong, since it will be showing UTC time or the time at Greenwich, England. However, all other navigation displays, including the position display will be correct. (You can set the time to your local time.) To speed up the satellite acquisition process, you can initialize the AccuNav II or "tell it where it is" the first time it's turned on. This initialization process is usually done only once and requires the following data:

1. Present position in latitude/longitude
2. Elevation above sea level (altitude)
3. Today's date and time

The unit usually only takes a few minutes or less to find the satellites once it's been initialized by the user.

After the power cable and GPS antenna module are installed, press the ON key, then press the MENU key. Now press the key next to the "CHANGE GPS SETTINGS" label. Finally, press the key next to the "SET LAT, LON, ALT, TIME, DATE" label. The screen shown below appears next.

This is the GPS setup screen. The settings now in use are shown at the top of the display. If you're using the unit for the first time, these settings are probably wrong for your position and time. To change any of the numbers on this display, simply press the key next to the arrow with the desired label. For example, to change the local time, press the key next to the "CHANGE TIME" label.

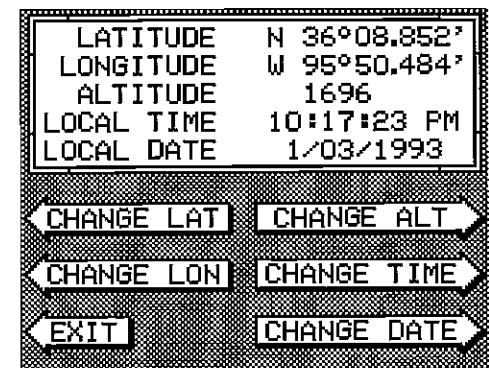

Note: If you don't use the "cold start" feature, then you will have to change all of the settings on this page to their correct values. In other words, you can't simply enter your present position and have the unit find the correct values by itself.

CHANGE POSITION

Use a chart to determine your position if you don't know it. The latitude/longitude that you enter doesn't have to be extremely accurate. Typically, if you enter a position within one degree of your present position, the AccuNav II should quickly find your actual latitude/longitude. To change your present position, first press the key next to the "CHANGE LAT" label. The screen shown below appears. Use the down arrow key to change the

"N" to "S", if necessary. Next, simply enter your present latitude using the numbered keys. Notice that the position entered is in degrees, minutes, and hundredths of a minute. (Not seconds!) If you make a mistake, press the left or right arrow keys to move to the number in the latitude that needs changing. After the latitude has been entered, press the key next to the "ACCEPT" label.

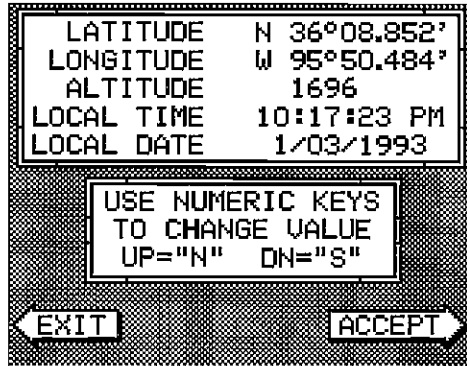

Now press the key next to the "CHANGE LON" label. The black box will be next to the "E" on the longitude. Again, use the up or down arrow keys to switch the "E" to "W" or west longitude, if necessary. Now enter the longitude using the numbered keys. Be certain to enter a zero "0" as the first number in the longitude if it's less than 100 degrees! After you've entered the last number, press the key next to the "ACCEPT" label.

CHANGE ALTITUDE

To enter your present altitude, press the key next to the "CHANGE ALT" label. The AccuNav II needs to know your elevation above sea level. (Not your height above the ground.) Again, an approximation is usually sufficient. Use the numbered keys to enter your altitude data. Press the up arrow key if your altitude is below sea level. For example, suppose you're in Death Valley and the spot you're standing in is 35 feet below sea level. You would need to enter the numbers "35", then press the up arrow key to change it to -35 feet. Press the key next to the "ACCEPT" label when you're done.

CHANGE TIME

To change the local time (the time at your position), press the key next to the "CHANGE TIME" label. The screen shown at the top of the next page appears.

ARRIVAL ALARM

The arrival alarm sounds a tone when your position is within the alarm's radius of a waypoint. For example, the alarm sounds if you come within .1 mile of a recalled waypoint if the arrival alarm's setting is .1 mile. The alarm is adjustable from .01 to 9.9 miles.

XTE ALARM

The XTE (cross track error) alarm sounds a tone when your cross track error is greater than the alarm's setting. Changing the XTE alarm also changes the XTE range on the steering screen. The alarm is adjustable from 0.0 to 9.9 miles.

ANCHOR ALARM

The anchor alarm sounds a tone when the present position moves outside a preset radius. For example, if you set the anchor alarm to .1 nautical mile (600 feet), then the alarm will sound if you move more than 600 feet from the location where you set the alarm. It's adjustable from 0.01 to 9.9 miles.

CHANGING GPS SETTINGS

The AccuNav II must be initialized when it's turned on for the first time. This is described at the beginning of the GPS section in this manual. However, if you wish to change only one of the parameters (such as time), use the menu features in the "CHANGE SETUP" menu. To do this, press the MENU key, then press the key next to the "CHANGE GPS SETTINGS" label. Finally, press the key next to the "SET LAT, LON, ALT, TIME, DATE" label. The screen shown below appears.

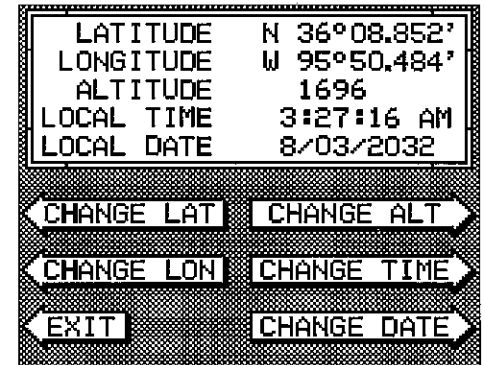

Using the menus on this and following menu pages, you can change the Initial Position, Time-Date-Time Offset, or Altitude without affecting any other initialization setting. All of these menus work identically to the ones described in the initialization section at the beginning of the GPS section. After you make a change, the unit returns to the GPS or plotter screen.

You may need to re-initialize the unit if you move a long distance (over 100 miles) with the unit off. In this example you would need to enter a new initial position to help the AccuNav II find the correct satellites quicker.



black box moves over the numbers on the right side. In the example shown at the top of the next page, the arrival alarm is selected.

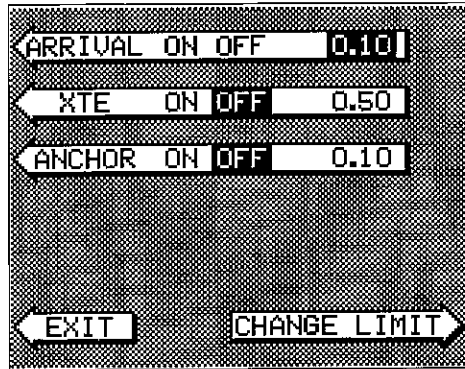

Now press the key next to the "CHANGE LIMIT" label. The screen shown below appears. The current alarm value shows in a window on the screen which is labeled "OLD VALUE"

Use the numbered keys to change the alarm's setting, then press the key next to the "ACCEPT" label to enter it. For example, to set the arrival alarm to .2 mile, press the 0 key, then the 2 key, then press the 0 key again. When the desired value has been entered, press the key next to the "ACCEPT" label. The unit returns to the ALARMS screen as shown below. Notice that the alarm has automatically been turned on. If an alarm is off, and you adjust it, the unit automatically turns it on.

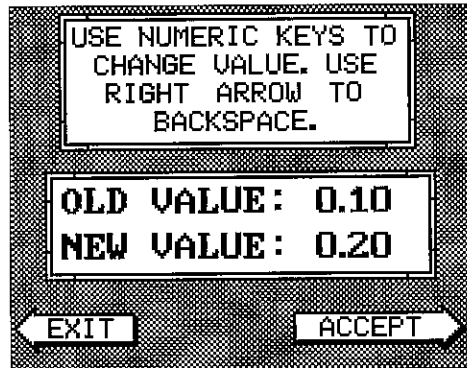

Remember, if you need to set an alarm to less than one (1), enter a zero first. For example, to set the arrival alarm to .5 miles, press the following number keys: 0 5 0.

Now you can change any other alarm or press the key next to the "EXIT" label to leave the alarm menu.

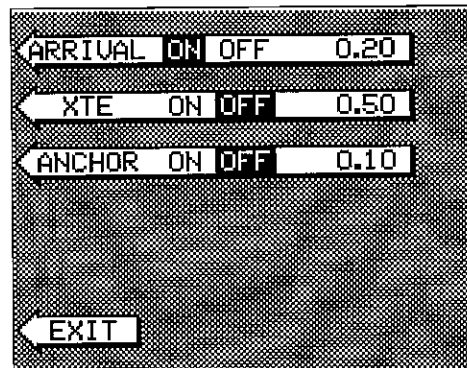

You can return to this alarm screen at any time to adjust any alarm, turn one off, or all of them on, as desired. Each alarm works and adjusts independently of the others. A description of each alarm follows.

Use the number keys to enter the time. Press the up arrow key to change the time from AM to PM or the down arrow key to change from PM to AM. Press the key next to the "ACCEPT" label when you're finished.

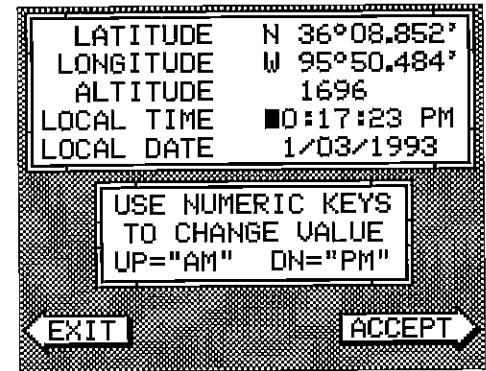

CHANGE DATE

To enter today's date, press the key next to the "CHANGE DATE" label. The screen shown below appears. Enter the date using the numbered keys. When you're finished, press the key "ACCEPT" label.

The numbers at the top of the screen should be correct. If they aren't, press the key next to the label that you need to change. If everything is correct, press the key next to the "EXIT" label. The unit will switch to the position screen and start searching for the satellites currently in view. It should find the satellites and show a position in a few minutes.

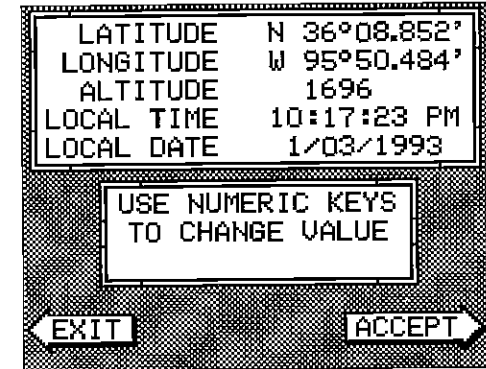

COLD START

When the AccuNav II is turned on for the first time "out of the box", it automatically sends a "cold start" message to the GPS receiver. You also can send a cold start message to the receiver.

If the unit can't lock on to the satellites using the data you've given it, or if it has trouble finding the satellites, perhaps it is using the wrong data. This can happen if you've entered the wrong data by accident. For example, given it east longitude instead of west. Or if you've moved a long distance with the unit turned off.

To send a cold start message to the receiver, press the MENU key. Now press the key next to the "CHANGE GPS SETTINGS" label. Finally, press the key next to the "GPS "COLD" START" label. The unit will begin a cold start technique to find the available satellites. It should lock on to them in 15 minutes or less. Remember, when it does, your local time and possibly

date display will probably be wrong. Use the method shown above to set the time and date to their proper local settings. Once this is done, an internal clock will keep the correct time, even when the unit is turned off. The GPS system updates this clock when the unit is locked on to the satellites.

POSITION/NAVIGATION DISPLAYS

The AccuNav II has a position screen, navigation screen, plotter, steering indicator, and a satellite information screen. These displays were designed to show the most important data. However, you can customize all of them (except the satellite position screen) to some extent through the "Change Display" feature on the first GPS menu screen. (There are other screens that can be customized by using the Windows feature. See the Windows section for more detail.) To customize these screens, see the "Customize" section.

IMPORTANT!

If the data shown in digital numbers on any screen on this unit is flashing, then it means that data is invalid. Do not rely on that data if it is flashing. For example, if the position display is flashing, then the unit has lost the satellites and hasn't re-acquired them. The position that is flashing is your last known position, not your present position! Do not navigate with this unit until you have found the reason the unit has lost the satellites!

Each of the following screens is available by first pressing the MENU key, then pressing the key next to the desired screen label. A detailed description of each screen follows. (Press the MENU key twice to see the Satellite Information menu.)

SATELLITE INFORMATION SCREEN

The satellite information screen shows technical data about each satellite in view. The AccuNav II has a five channel GPS receiver. Data on each channel is shown at the top of the display. The channels are numbered one through five on the left side of the screen. Every satellite in the constellation has a number assigned to it, called the PRN. The PRN is the first number in the channel's row. TRK stands for "track." If the AccuNav II is tracking the satellite, then a "T" is placed in this column. If the AccuNav II is

CHN	PRN	TRK	ELV	AZM	SNR
1	13	T	60°	311°	35
2	12	S	27°	324°	29
3	02	T	46°	115°	43
4	24	T	23°	208°	42
5	14	T	19°	74°	35
DOPs			VISIBLE SATS		
HDOP	1.69		13	02	06 24
GDOP	3.87		12	14	
PDOP	3.33				
TDOP	1.98				
VDOP	2.87				

ERASING A ROUTE

To create a route, first press the MENU key. Next, press the key next to the "More" label. Now press the key next to the "ROUTE PLANNING" label. Route number one appears on the right side of the screen. The list of waypoints used in the route are shown beneath the route number and name. If you wish to erase a different route, press the key next to the "+RTE" or "-RTE" labels to cycle through the available routes.

After you've selected the desired route, press the key next to the "ERASE RTE" label. This erases the route from memory. Finally, press the key next to the "EXIT" label. This returns you to the GPS display.

GPS ALARMS

The AccuNav II has three GPS alarms. One is an arrival alarm that sounds when you come within a preset distance to a waypoint. The next is a cross track error alarm that sounds when you move off course more than the alarm's setting. The last alarm is an anchor alarm. It sounds when you move outside of a preset radius. All of these alarms are set identically.

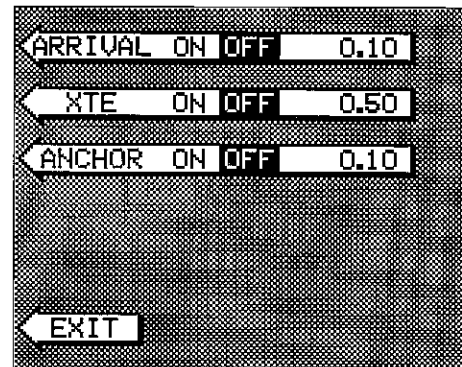

To adjust a GPS alarm, press the ALARM key. The screen shown above appears. To turn any alarm on, press the key next to the desired alarm's label until the black box moves to "ON", as the screen below shows. To change an alarm's setting, press the key next to the desired alarm until the

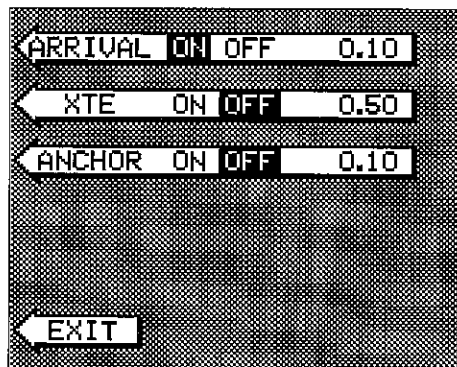

IMPORTANT!

Turning the arrival alarm off prevents the AccuNav II from sequencing to the next waypoint in the route. This, in effect, turns the route off. However, the unit will still show navigation data to the current waypoint in the route at the time the arrival alarm was turned off.

CANCEL NAVIGATION

To stop the AccuNav II from navigating to waypoint or navigating to a waypoint in a route, press the MENU key twice. Now press the key next to the "CANCEL NAVIGATION" label. This stops all navigation.

NOTE:

Canceling navigation does not erase the route or any waypoints from memory. It merely stops the AccuNav II from navigating.

MODIFYING A ROUTE

Any part of a route can be changed at anytime. For example, suppose you have a route consisting of waypoints number 1, 2, and 3 and you wish to change waypoint number 3 to waypoint number 5. Simply press the MENU key, then press the key next to the "More" label. Next, press the key next to the "Route Planning" label. Finally, press the key next to the "Recall Route" label. Route number one appears on the right side of the screen. The list of waypoints used in the route are shown beneath the route number and name.

Using the down arrow key, move the black box to waypoint number 3. Now press the key next to the "CHANGE" label. Use the numbered keys to change the waypoint from 3 to 5. Next, press the key next to the "ACCEPT" label. You've changed the waypoint from 3 to 5. Finally, press the key next to the "EXIT" label and you're finished.

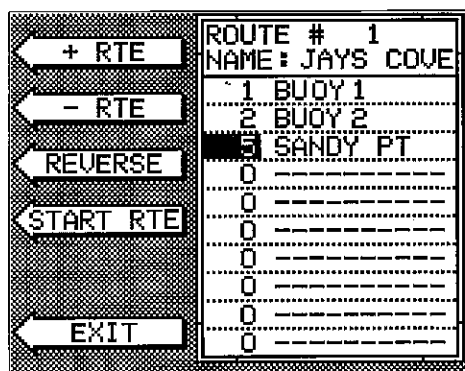

Remember, any part of the route can be changed at any time.

searching for the satellite, then a "S" appears. ELV is the elevation (height) of the satellite above the horizon from your position. AZM is the azimuth or direction of the satellite from your position. For example, if the azimuth of a satellite is 180 degrees, then it is due south. SNR is the signal-to-noise ratio. This tells you how strong the satellite's signal is. The higher the SNR number, the better.

The satellites that are visible in the sky from your position are shown in the lower right corner of the screen under the "VISIBLE SATS" heading.

In the lower left corner of the screen are the DOPS displays. These show you the "Dilution Of Precision" (DOP) for the horizontal (HDOP), geometric (GDOP), position (PDOP), time (TDOP), and vertical (VDOP). The GDOP is the combination value of HDOP, VDOP, and TDOP. The smaller the GDOP's number is, the better. The GPS receiver selects satellites based on GDOP, therefore it always tries to use satellites that have good DOP values. These depend on the azimuth and elevation of the satellite, and any ground based obstructions.

Remember, the smaller the number - the better on all of the DOPs.

POSITION SCREEN

The position screen automatically appears after the AccuNav II is initialized or you can view this screen at any time by pressing the POS key. The position display shows your present position, course over ground (COG), cross track error (XTE), bearing (BRG), and local time.

Your present position displays near the top of the screen in latitude/longitude coordinates. This is shown in minutes, and thousandths of a minute. For example, on this page, the present position is 31 degrees, 8.642 minutes latitude and 82 degrees, 50.853 minutes longitude. Below the present position on the left side is the Bearing to Waypoint (BRG) display. This is expressed in degrees true or magnetic, depending on the mode the AccuNav II is in. To the right of the Bearing is the Course Over Ground (COG) display.

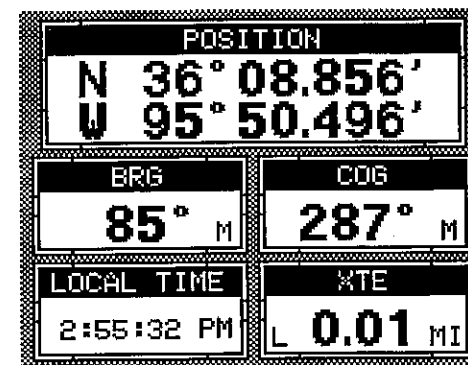

At the bottom of the screen are the Local Time and Cross Track Error Displays. Please note that you must recall a waypoint to use the Bearing and Cross Track Error displays.

STEERING SCREEN

The steering screen shows a pictorial view of your boat and course travelled. This is called a Course Deviation Indicator or CDI. It also shows Distance To Go (DTG), Speed Over Ground (SOG), Bearing to Waypoint (BRG), and Course Over Ground (COG). Press the STEER key to view this screen.

Your present position is shown by the arrow. The arrow shows the direction the boat is heading relative to the waypoint. In theory, if you steer the boat with the arrow always pointing towards the waypoint, then you will arrive at the waypoint. The solid line extending from the arrow is your track or path you've taken. To travel directly to a waypoint, try to keep the arrow on the center line. The waypoint is depicted by a box at the top of the CDI display. As you approach the waypoint, the arrow and the box will move closer together. If you travel past the waypoint, the waypoint's box will move to the bottom of the display.

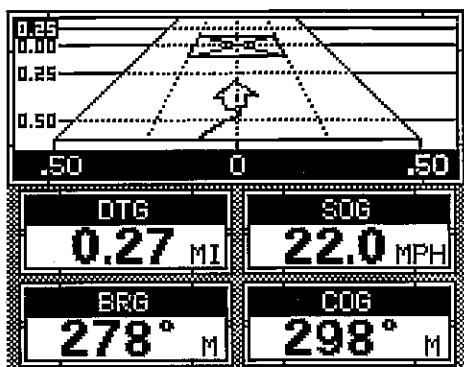

The numbers on the top left side of the screen are distance markers, showing the remaining distance to the recalled waypoint. If the numbers have a black box surrounding them, then the distance markers is showing the distance PAST the waypoint. In other words, if the numbers are surrounded by a black box, then you have passed the waypoint and need to turn around.

The numbers immediately below the CDI are the CDI range in miles. This gives you an idea of how far off course you are. For example, if the arrow is halfway between the course line and the outside left line and the CDI range is 0.5 miles, then your cross track error is to the left 0.25 miles. The CDI range is the same as the CDI alarm setting. See the section on GPS alarms to change the CDI range.

Using the digital displays at the bottom of the screen with the graphical

press the key next to the "CHANGE" label and enter the waypoint number for the second waypoint in the route. Continue entering the waypoints until all of the waypoints have been entered for the route. Then press the key next to the "EXIT" label. This saves your route in memory.

IMPORTANT!

You must select waypoints in the order they are to be used in the route. In other words, suppose you want a route that consists of waypoint numbers 1, 3, and 5. However, you wish to travel to 3 first, then 1, and finally 5. In this case, you must select waypoint 3, 1, and 5 in that order when making the route.

FOLLOWING A ROUTE

To follow a route, press the MENU key, then press the key next to the "More" label. Next, press the key next to the "Route Planning" label. Finally, press the key next to the "Recall Route" label. The screen shown below appears. Route number one appears on the right side of the screen. The list of waypoints used in the route are shown beneath the route number and name. If you wish to recall a different route, press the key next to the "+RTE" or "-RTE" labels to cycle through the available routes.

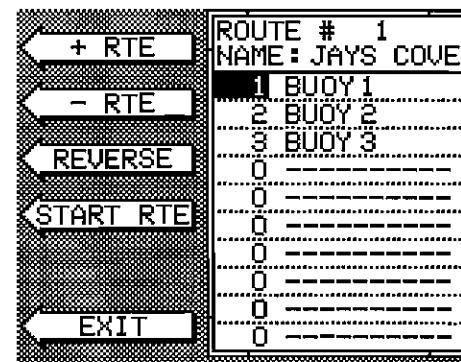

After you've selected the desired route, you'll notice a black box surrounding the first waypoint in the route. This is the starting waypoint box. If you wish to start the route using the first waypoint in the route, simply press the key next to the "START RTE" label. However, if you wish to start the route using a different waypoint, simply use the down arrow key to move the black box to the desired waypoint number. Then press the key next to the "START RTE" label.

To follow a route backwards, press the key next to the "REVERSE" label. For example, suppose you have three waypoints in a route and they're numbered 3, 6, and 2. If you travel forward through the route, the unit will show navigation data to waypoint number 3 first, then 6, and finally 2. If you travel backward through the route, the unit will start with waypoint number 2 first, then 6, and end with waypoint number 3. No matter if you travel forward or reverse through the route, when you reach the last waypoint in the route, the arrival alarm sounds until you turn it off.

This menu lets you select the route number, name the route, and choose the waypoints used in the route.

Name a Route

To assign a name to a route, press the key next to the "+RTE" or "-RTE" label to move through the list of routes. When the desired route number appears in the window at the top of the screen, press the down arrow key until the black box moves to the "NAME" position. Now press the key next to the "CHANGE" label. The screen shown below appears.

Use the keys on both sides of the screen to enter the waypoint name. For example, to name a route "REEF 1", press the number "4" key repeatedly until the letter "R" appears in the window. Next, press the right arrow key to move the black box to the next letter position. Now press the "1" key. The letter "E" appears on the screen. Repeat this process until the entire name has been written on the screen. Now press the key next to the "ACCEPT" or "ENTER" label. The AccuNav II returns to the route menu. You can now enter the waypoints used in the route.

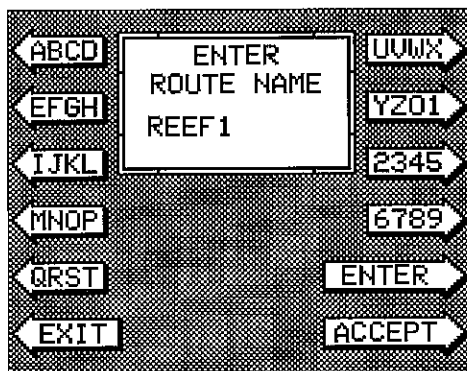

Waypoint Selection

If you've named a route, the black box should be on the "0" at the top of the screen. If not, move the black box to the "0" using the up or down arrow keys. Now press the key next to the "CHANGE" label. The screen shown below appears.

Now press the numbered key of the waypoint you wish to go to first in the route. For example, if you want waypoint number 8 to be first, press the 8 key. If you've named the waypoint, it shows in the blank space to the right of the waypoint number. Next, press the key next to the "ACCEPT" label. The cursor should now be on the second waypoint line. Again,

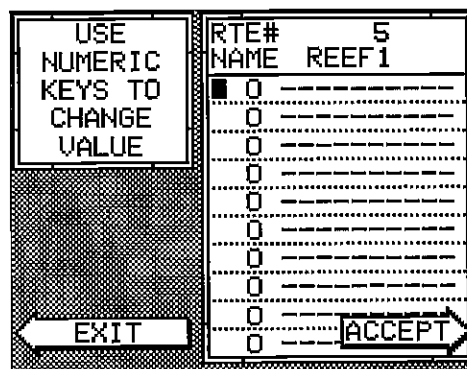

display at the top let you accurately steer the boat to a waypoint.

NAVIGATION SCREEN

Use the navigation screen when you're navigating to a waypoint. It shows your Distance To Go (DTG), Bearing to Waypoint (BRG), Local Time, Speed Over Ground (SOG), Course Over Ground (COG), and Cross Track Error (XTE). To use the navigation screen, first recall a waypoint, then press the NAV key. A screen similar to the one above appears.

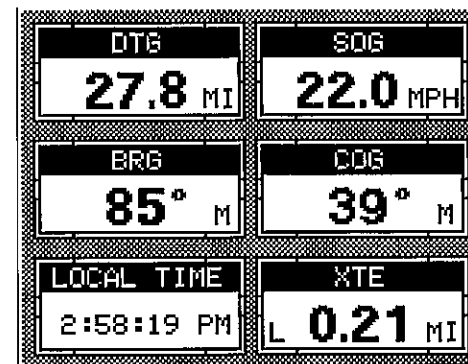

CUSTOMIZE SCREENS

The digital displays on the bottom half of the Position and Steering screens, plus all the displays on the Navigation screen can be changed as desired. To show how this is done, we'll use the Position screen as an example.

To customize the Position Screen, first press the MENU key. The first GPS menu screen appears. Press the key next to the "CHANGE POSITION DISPLAY" label. The unit returns to the Position Screen with a black box around the Bearing (BRG) label.

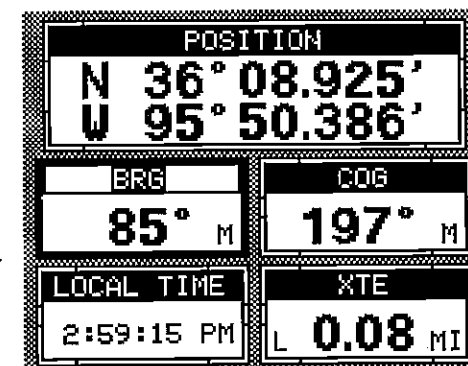

The black box identifies the Bearing box as "ready for change." To change the Bearing display, press the up or down arrow keys to select the display that you want to show inside the box.

In this example, we changed the Bearing display to DTG (Distance To Go) by pressing the up arrow key twice.



NORMAL DISPLAY



DISPLAY READY FOR CHANGE

To change another digital display, press the left or right arrow key. The label in the next digital display box changes as you press the arrow key. Again, press the up or down arrow key to change the display.

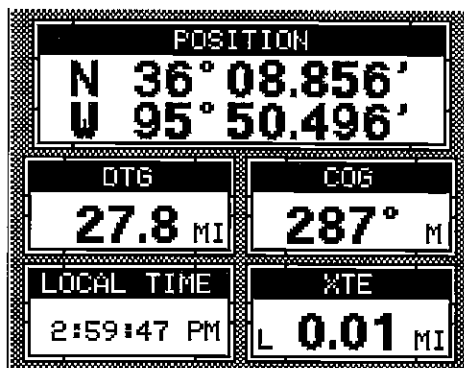

The digital displays available for use are:

- BRG Bearing
- SOG Speed Over Ground
- DTG Distance To Go
- DEST WPT Destination Waypoint
- POSITION Present Position
- ALT Altitude
- RTE NAME Route Name
- WPT NAME Waypoint Name
- TTG Time To Go
- XTE Cross Track Error
- LOCAL TIME Time at your location
- COG Course Over Ground

When you have the display arranged as desired, press the CLEAR key. This “locks” the display. Every time you switch to this display, it will appear as you designed it, unless you preset the unit.

PLOTTER

The plotter lets you see your course and direction of travel on the screen. If you’ve recalled a waypoint, the plotter shows your starting location, present position, and destination. However, you do not have to recall a waypoint to use the plotter.

The plotter also can show grid lines on the display. These grid lines show latitude and longitude lines that can help you visualize your position or the location of other objects.

To use the plotter, simply press the PLOT key. A screen similar to the one at the top of the next page appears.

The flashing cross is your present position. The solid line is your track, or path you have just traveled. The large square is a compass rose marked

Now press the key next to the “+ WPT” or “-WPT” label until the desired waypoint number appears on the screen. When it does, simply press the key next to the “GO TO WYPOINT” label. The AccuNav II returns to the last used sonar, navigation, or plotter screen, showing navigation data to the waypoint you recalled.

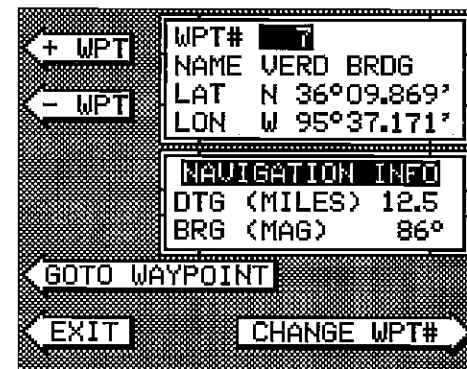

ROUTES

A route gives you the ability to navigate to several waypoints without having to re-program the unit after arriving at each one. A route consists of two or more waypoints. When you travel on a route, the AccuNav II first shows navigation information to the first waypoint in the route. When you reach the first waypoint, (signalled by the Arrival Alarm), the AccuNav II automatically sequences to the next waypoint. Navigation information is shown to this waypoint and the process repeats. When you reach the last waypoint in a route, the arrival alarm sounds until you turn it off.

There are four steps required to create and follow a route. First, you must create and name the route. Next, select the waypoints used in the route. Then determine the starting waypoint. Next, tell the unit to follow the route. Finally, the unit will ask you if you wish to run the route forward or backward. After these steps are completed, the AccuNav II will start showing navigation data to the first waypoint on the route.

CREATING A ROUTE

To create a route, first press the MENU key. Next, press the key next to the “More” label. Now press the key next to the “ROUTE PLANNING” label. Finally, press the key next to the “SAVE/EDIT ROUTE” label. The screen shown at right appears.

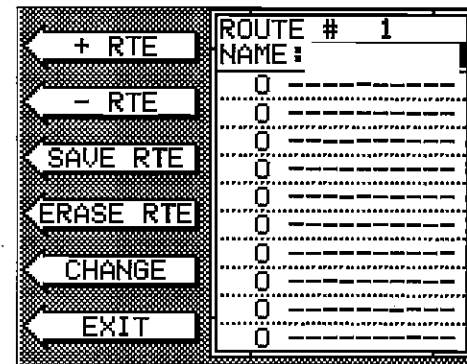

name. For example, to name a waypoint "COVE 1", press the number "0" key repeatedly until the letter "C" appears in the window. Next, press the right arrow key to move the black box to the next letter position. Now press the "3" key repeatedly until the "O" appears on the screen. Repeat this process until the entire name has been written on the screen. Now press the key next to the "ACCEPT" or "ENTER" label. The AccuNav II returns to the waypoint save menu as shown above. To save the waypoint with this name, first press the key next to the "SAVE" label. Now press the key next to the "EXIT" label to exit the waypoint save menu.

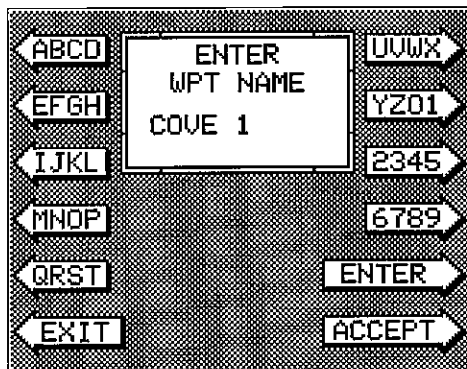

Erase a Waypoint

The Waypoint Erase feature lets you delete waypoints from the list.

To erase a waypoint, first press the WAYPT SAVE key. Now press the key next to the "+ WPT" or "- WPT" label until the desired waypoint number appears on the screen. Simply press the key next to the "ERASE" label. The screen shown at right appears. A message appears on the screen that says "WAIT!! DELETE WAYPOINT ARE YOU SURE?". If you are certain this is the waypoint that you wish to erase, press the key next to the "YES" arrow. If not, press the key next to the "NO" arrow. Press the key next to the "YES" arrow erases all information from the waypoint number that appears at the top of the screen.



To exit from the waypoint save menu, press the CLEAR key.

RECALL A WAYPOINT

You must recall a waypoint in order to navigate to that position with the AccuNav II. To recall a waypoint, first press the WAYPT RECALL. The screen shown at the top of the next page appears.

with North, South, East, and West. The square's height and width shows at the bottom of the screen. This is the distance from one side to the other and from the top to the bottom. Your present position is shown at the top of the screen.

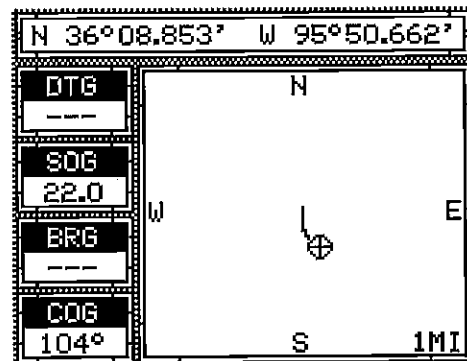

If your present position starts to move outside the square, the AccuNav II clears the display, then re-draws your present position closer to the center of the screen. Your present position will always be displayed on the plotter.

To clear the plotter screen, see the Plotter Menus section.

On the left side of the screen are the Distance To Go (DTG), Bearing (BRG), Speed Over Ground (SOG), and Course Over Ground (COG) digital displays. All of these displays are used when a waypoint is recalled, except COG that is always active. These displays also can be customized. See the Plotter Menus section for more detail.

PLOTTER CURSOR

The plotter cursor can help you determine the latitude/longitude of a waypoint or event marker. To use it, press the up or down arrow key while the plotter is displayed. A screen similar to the one below appears. Two new lines appear on the screen. These are the plotter cursor lines. Also, the present position display at the top of the screen switches to show the latitude/longitude position of the plotter cursor - not your present position. Use the arrow keys to move the plotter cursor lines to the desired location. To erase the cursor lines, press the CLEAR key. This also will switch the position display at the top of the screen back to showing your present position.

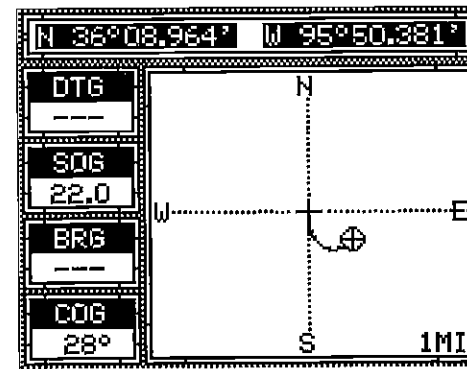

PLOTTING WITH A WAYPOINT

Using the plotter with a recalled waypoint or route is an easy way to see the effects of wind

and current on your boat. It also simplifies navigation. To use the plotter in this manner, first recall a waypoint or start a route. (See the Waypoint Recall section for more information.) Then press the PLOT key. A screen similar to the one at right appears.

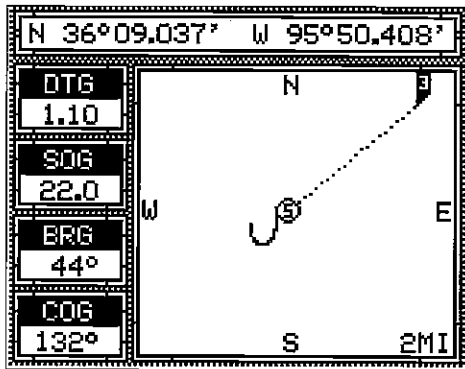

The "S" is your starting location. This was your position when you recalled the waypoint.

The flashing circle with a cross is your present position. The "flag" with a number inside is the destination (recalled waypoint). The number inside the flag is the recalled waypoint number. In this example, waypoint number 10 is the destination. The dotted line is the shortest, most direct course from the starting point to the destination. Follow this line to get to the waypoint.

An arrival alarm can be set to sound a tone when you come within a preset distance to the destination. See the section on alarms for more information about the arrival alarm.

PLOTTER MENUS

Pressing the MENU key while the plotter displays gives you a new set of menus that relate only to the plotter. There are two pages of plotter menus.

PLOTTER MENU - PAGE 1

CLEAR PLOT

To clear or erase the solid track line from the screen, use the Clear Plot menu selection. The plotter will continue to draw your track after this key is pressed, starting from your present position.

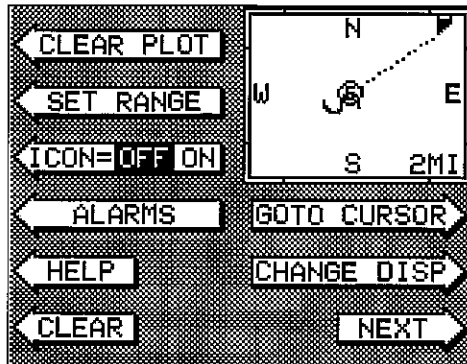

SET RANGE

Use this menu to change the plotter's range or distance across the plotter's display. The range is 1 statute mile when the

Enter New Waypoint

To save a location other than your present position, first press the WAYPT SAVE key. Using the up and down arrow keys, move the black box down to the latitude/longitude position. Now press the key next to the "CHANGE FIELD" label at the bottom right corner of the screen. The screen shown

below appears. Use the arrow keys to change the "N" to a "S", if your latitude is south. Now enter the location you wish to save using the numbered keys. Use the left arrow key as a backspace if you make a mistake. In other words, pressing the left arrow key moves the black box over the last number entered. Notice that the position entered is in degrees, minutes, and hundredths of a minute. (Not seconds!) After you've entered the latitude, press the key next to the "ACCEPT" label. The waypoint save menu reappears. Next, press the key next to the "CHANGE FIELD" label. Press the down arrow key to switch the longitude from west to east, if necessary. Now enter the longitude. Make certain to add a zero to the longitude if it's less than 100 degrees. For example, if the longitude is 85 degrees, then enter "085". Press the key next to the "ACCEPT" label when you've finished. The save waypoint menu appears with the position you entered in the waypoint position box at the top of the screen. If this position is correct, press the key next to the "SAVE" label.

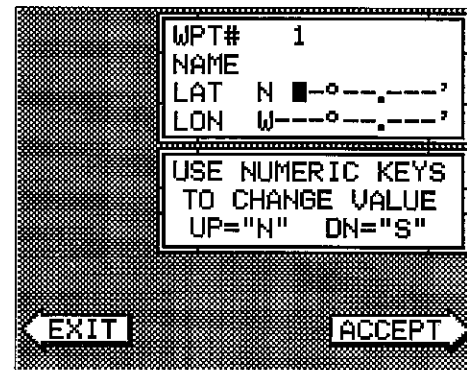

Name a Waypoint

To assign a name to a waypoint, press the WAYPT SAVE key. The waypoint save menu appears. Press the key next to the "+WPT" or "-WPT" label to move through the list of waypoints. When the desired waypoint appears in the window, press the down arrow key until the black box moves to the "NAME" position. Now press the key next to the "CHANGE FIELD" label. The screen shown at right appears.

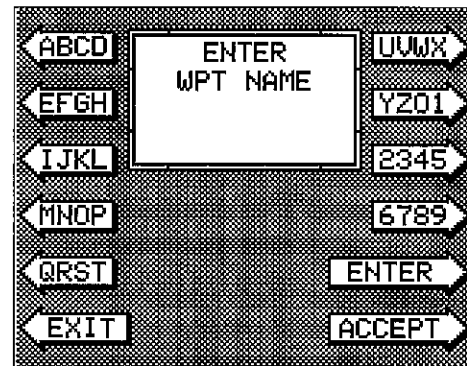

Use the keys on both sides of the screen to enter the waypoint

Saving Present Position as a Waypoint (Quick Save Feature)

The AccuNav II lets you save your present position as a waypoint with only one key press. This "Quick Save" feature lets you easily save the position of a wreck or other locations.

To save your present position as waypoint, simply press the WAYPT QUICKSAVE key. The AccuNav II takes your present position and assigns the first available waypoint number to it.

Saving Present Position - View and Save Method

The "Quick Save" feature doesn't let you select the waypoint number. You have to use the next available number when using that method. The View and Save method lets you pick the waypoint number that your present position is stored in. (Note: You can store a position under a waypoint number that already has a position assigned to it using this method.) To save your present position, press the WAYPT SAVE key. A screen similar to the one below appears.

The first waypoint number in the list appears at the top of the page. This is the number that your present position will be stored under. Your position at the time you pressed the WAYPT SAVE key is shown in the "CURRENT POSITION" box in the middle of the screen. If you wish to save the location in the CURRENT POSITION box under this waypoint number, simply press the key next to the "USE CURRENT POSITION" label. The position shown in the CURRENT POSITION box also will show in the waypoint location at the top of the screen. To save the waypoint without naming it, simply press the key next to the "SAVE" label.

To save the location under a different waypoint number, press the key next to the "+ WPT" label to increase the waypoint number (i.e. from waypoint number 1 to 2). Press the key next to the "- WPT" label to decrease the waypoint number. Once you've decided the waypoint number to save the location under, press the key next to the "USE CURRENT POSITION" label. Then press the key next to the "SAVE" label. This will store the location under the waypoint number you selected and return to the last used position, plot, or navigation screen.

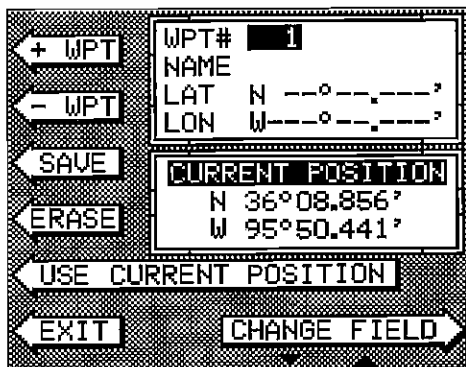

AccuNav II is turned on for the first time. The available plotter ranges are .1, .2, .5, 1, 2, 5, 10, 20, 50, and 100 miles. This lets you "zoom in" to see small variations in your course or "zoom out" to see your starting position, present position, track, course, and destination.

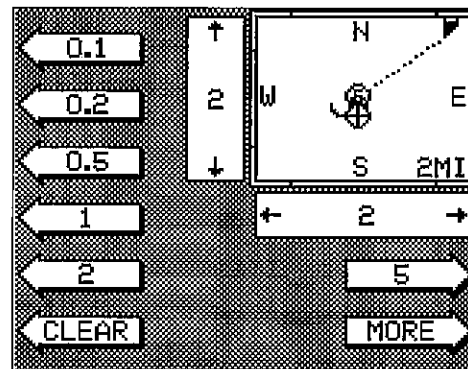

ICON ON/OFF

Pressing this key turns on the icons that you placed on the screen using the EVENT MARKER key. For more information on this feature, see the Event Marker section. This also turns on all of the waypoint icons, also.

ALARMS

Press this key for the alarms menu. For more information on the alarms, see the ALARMS section.

GOTO CURSOR

As previously described, the cursor lines can be used to place an icon or highlight a position. When you use the cursor lines, the position of the cross hairs on the display are shown at the top of the screen. Pressing the key next to the "GOTO CURSOR" label on the plotter menu causes the AccuNav II to show navigation and steering data to the position shown by the cross hairs. This automatically turns the arrival alarm on, also.

To use this feature, first move the cursor lines to the desired location on the plotter screen. Next, press the MENU key. Finally, press the key next to the "GOTO CURSOR" label. The unit returns to the plotter screen. A waypoint flag appears on the screen (numbered "0") that was the location of the cursor cross hairs when you pressed the key next to the "GOTO CURSOR" label.

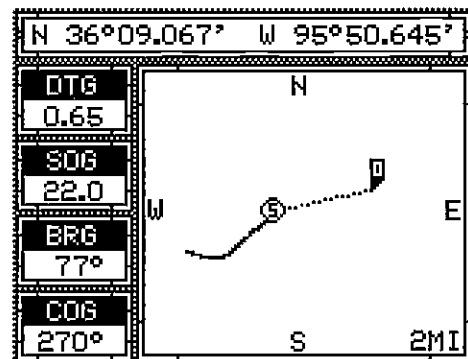

All of the navigation displays on the AccuNav II will show navigation data to the location you marked. This includes the navigation, steering, and plotter displays.

CHANGE DISPLAY

The four digital displays on the left side of the plotter screen can be changed or customized at will. When the AccuNav II is first turned on, or after it's preset, the four digital displays are Distance To Go (DTG), Speed Over Ground (SOG), Bearing to waypoint (BRG), and Course Over Ground (COG). The available displays that can be placed in these windows are: Distance To Go (DTG), Speed Over Ground (SOG), Bearing to waypoint (BRG), Course Over Ground (COG), Cross track error (XTE), and Altitude (ALT).

To change any or all of the digital displays, first press the MENU key while the plotter is showing. Now press the key next to the "CHANGE DISPLAY" label. The unit returns to the plotter screen with a black box surrounding the DTG box. This means the DTG box is ready to be changed. Press the left or right arrow key to change the display. For example, to change the Distance To Go to Cross Track Error (XTE), press the right arrow key four times.

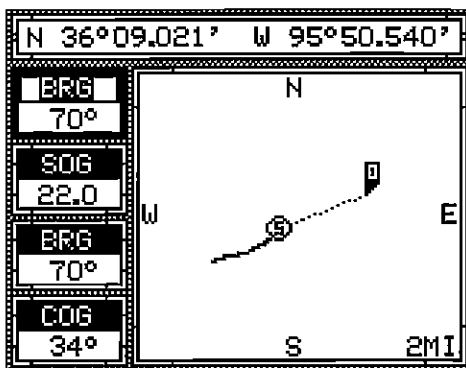

To change another digital box, press the up or down arrow key until the flashing box is on the desired display. Now press the right or left arrow key until the desired display appears.

When you have the digital displays customized, press the CLEAR key. This locks the screen displays, even if the unit is turned off and on again.

PLOTTER MENU - PAGE TWO

SELECT UNITS OF MEASURE

The AccuNav II can display distance in miles, kilometers, or nautical miles, velocity in miles per hour, kilometers per hour, or knots, bearing in degrees magnetic or true, Altitude in feet or meters, and time in 12 hour or 24 hour format.

To change any these, first press the menu key twice. Next, press the key next to the "SELECT UNITS OF MEASURE" label. The screen shown below appears. The black box on each line shows the unit of measure currently in use. In the screen shown below, the units of measure are in

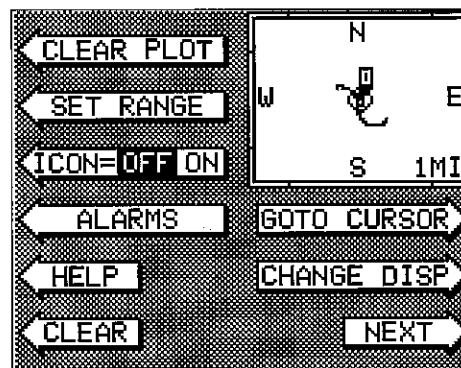

Two of these labels are window menus. Pressing the key adjacent to one of the "window menu" labels gives you a menu with functions that relate only to that window. For example, if you press the key adjacent to the plotter menu label on the plotter window, the screen will clear and you will have a new menu as shown above with selections such as "CLEAR

PLOT" and "GOTO CURSOR". This is the normal plotter menu screen. To exit from a window menu, press the CLEAR key.

VIEWING WINDOWS OPTIONS

To see all of the available windows, press the WINDOWS key, then press the MENU key. Now press the key adjacent to the "MAIN MENU" label. Finally, press the key next to the "VIEW ALL WINDOWS" label. The screen at right appears.

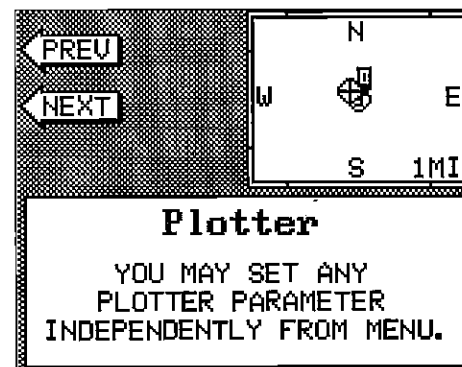

The first window appears in the upper right corner of the screen. A description of the screen shows in the box at the bottom of the screen. Now press the key adjacent to the "NEXT" label. This changes the displayed window and description. When you've finished viewing the windows, press the CLEAR key.

WAYPOINT NAVIGATION

HOW TO SAVE A WAYPOINT

Waypoints are locations on the earth's surface that you wish to go or return to. Waypoints are useful for marking shipwrecks, hot fishing spots, and other fishing or navigation locations. Storing waypoints in the AccuNav II's memory makes it easy to return to any point in the world by simply pressing a few buttons. The AccuNav II can store up to 200 waypoints. You can store your present position as a waypoint or enter latitude/longitude positions as waypoint locations.

WINDOWS

You can change the displays on the AccuNav II by using the windows feature. This lets you use different displays to suit your own fishing or boating situations. The screens available in the windows mode are divided into two or more windows per screen. Each screen of windows is called a "group". This AccuNavII gives you 8 different window groups. Group "A" as shown at right has the plotter, Course Over Ground, and steering displays showing in three separate windows. A group can have as many as four windows. A window can display digital GPS data, GPS steering or navigation displays, and many more.

To use the windows feature, first press the WINDOWS key.

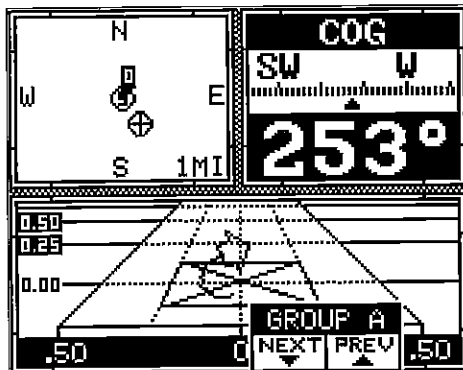
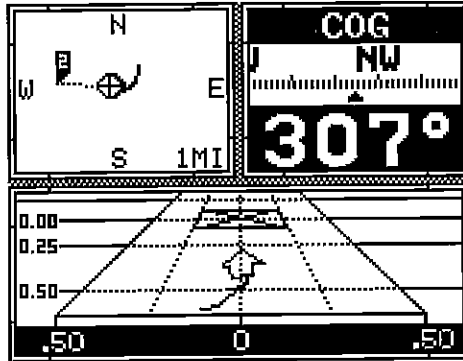

A screen similar to the one shown at left appears. The menu at the bottom of the screen lets you switch between the "pages" of displays. These are lettered "A" through "H". Group "A" shows first. Press the down arrow key to move forward through the screens. Press the up arrow key to move backward.

For example, pressing the down arrow key once shows the group "B" screen. To exit the windows mode, press the POS, PLOT, NAV, or STEER keys. Every one of the group screens can be modified to some extent. For example, press the MENU key while group "A" is displayed. Four new labels appear on the display as shown at right.

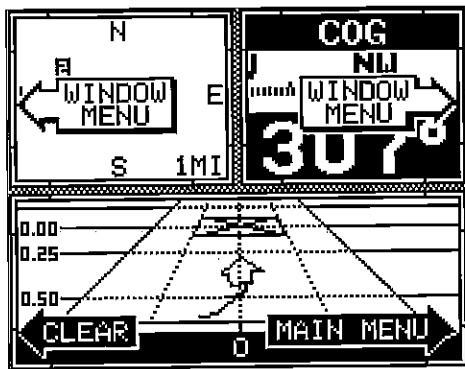

statute miles for distance, miles per hour for velocity, degrees magnetic for bearing, altitude in feet, and time is in the 12 hour format (a.m./p.m.)

Press the key next to the unit that you wish to change. For example, press the key next to the Distance label twice to switch from miles to kilometers. This moves the black box two times from the "MI" to the "KM".

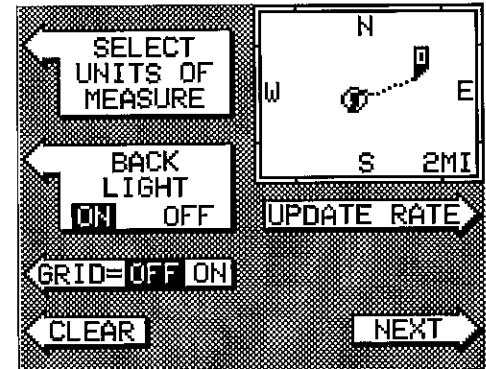

When you have the units of measure set as desired, press the key next to the "EXIT" label.

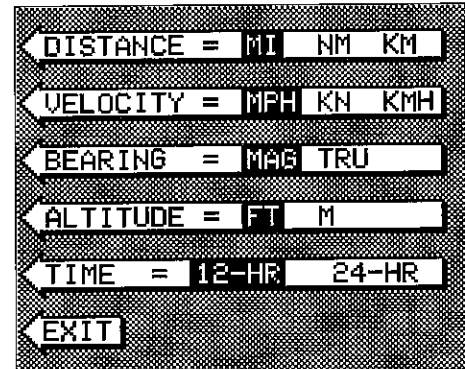

BACK LIGHT ON/OFF

To turn the back lighting on, press the menu key twice, then press the key next to the "BACK LIGHT" label. This moves the black box from "OFF" to the "ON" position. To turn the backlights off, repeat the steps.

GRID LINES

The plotter can show latitude/longitude grid lines by pressing the key next to the "GRID OFF/ON" label on the second plotter menu page. To turn the grid lines off, repeat the previous step.

PLOTTER UPDATE

The plotter shows your track by drawing a solid line behind your present position. The track is updated once every instantly when the unit is turned on for the first time. However, if you're

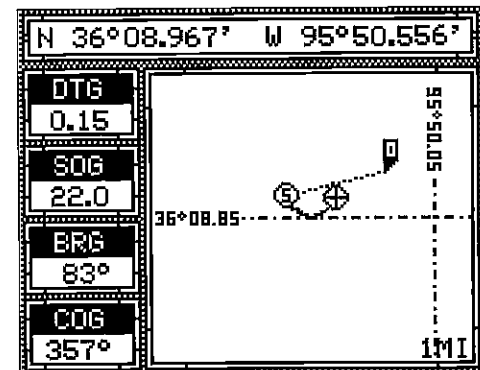

travelling a long distance, the track line may end prematurely due to the limited number of dots available that plot the track. Using a longer update time To change the update rate, press the MENU key while the unit is in the plotter mode. Now press the key next to the PLOT UPDATE label. The screen shown above appears. The available plot update times are instant, 2, 5, 10, and 20 seconds. Simply press the key next to the desired update time. The AccuNav II immediately returns to the plotter screen using the new time.

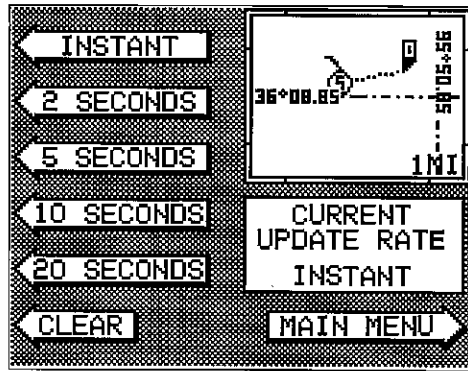

EVENT MARKER

The AccuNav II can place event markers or “icons” on the plotter to mark fishing spots, shallow water, or other special locations. There are five different icons to choose from and there are 100 of each icon for a total of 500. You can place each icon individually, however, you have to erase all of the icons in a group.

To place an icon, first press the EVENT MARKER key. The screen shown below appears.

Now select one of the five icons shown on the left side of the screen by pressing the key next to the desired icon. As soon as you press the key, the AccuNav II places the icon at your present position. This icon always stays in this location. It's saved in memory so it will always show on the display, even if the unit is turned off and on again.

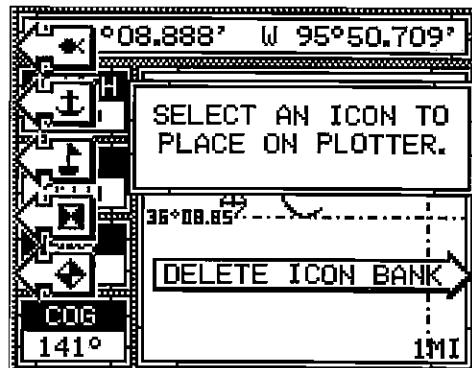

Using the Event Marker with the Cursor

Normally, when you select an icon, it's placed on the plotter at your present position. However, you can place an icon anywhere on the plotter using

the cursor. To do this, first press one of the arrow keys. This makes the plotter cursor lines appear on the display. Now move the lines to the desired position on the display by pressing the arrow keys. When it's at the desired location, press the EVENT MARKER key, then select an icon. The AccuNav II places the icon at the intersection of the plotter cursor lines.

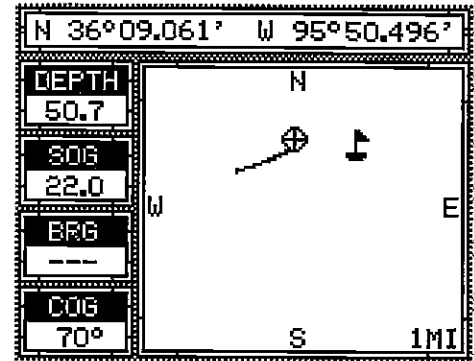

To erase the cursor lines, press the CLEAR key.

Erasing the Icons

Although you can place icons on the plotter individually, you can't erase them one at a time. You have to erase the whole group of icons. For example, if you've place 20 fish symbol icons, erasing one of them erases all 20.

To erase an icon, first press the EVENT MARKER key. Next, press the key next to the “DELETE ICON BANK” label. The screen shown below appears.

Now select the group of icons that you wish to erase by pressing the key next to the desired icon. After pressing the key, the AccuNav II erases all of the selected icons from the plotter.

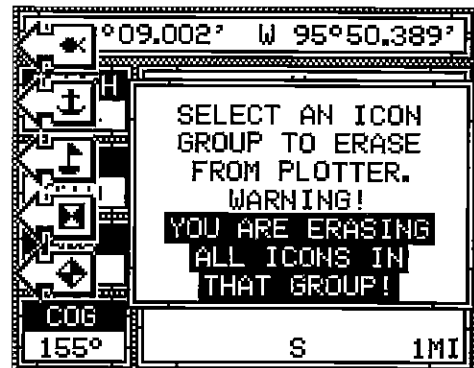

HELP

An extremely useful feature incorporated into the AccuNav II is the Help menus. Virtually every feature has a help menu label that, when pressed, gives one or more pages of text describing how to use that feature. For example, pressing the MENU key shows the first menu page. A help label also appears on the screen. Pressing the key adjacent to the help label gives you a description of each of the menu items and how they work.